

# HOTEL BREAKFAST

FAS•ITALIA  
FORNITURE PER ALBERGHI



# FAS•ITALIA

FORNITURE PER ALBERGHI

## I NOSTRI PUNTI DI FORZA

### Ampia gamma di prodotti

Poter concentrare molti acquisti su un unico fornitore offre sicuramente non solo vantaggi economici ma anche di tempo.

### Prezzi competitivi

Il nostro obiettivo è quello di proporre solo articoli con il miglior rapporto qualità/prezzo.

### Offerte chiare e concrete

I nostri preventivi non lasciano dubbi!

### Qualità

I nostri articoli sono stati selezionati privilegiando prodotti di qualità cercando di ottimizzare i costi per offrire un servizio di alto livello e prezzi concorrenziali.

## CONSEGNE IN TUTTA ITALIA

Siamo a disposizione per richieste di preventivo e informazioni pre e post vendita,

**dal lunedì al venerdì**

**dalle 9:00 alle 13:00 e dalle 14:00 alle 18:00**

## I NOSTRI CONTATTI



055 470536 / 055 2479578



055 474345



[www.salacolazione.it](http://www.salacolazione.it)



[info@fas-italia.it](mailto:info@fas-italia.it)



[youtube.com/forniturealberghi](https://youtube.com/forniturealberghi)



[instagram.com/fas\\_italia/](https://instagram.com/fas_italia/)



[FASItalia](https://www.facebook.com/FASItalia)



# VALO



## GN 1/1 Holzbox „VALO“

GN 1/1 woodbox  
GN 1/1 caja madera  
GN 1/1 base bois

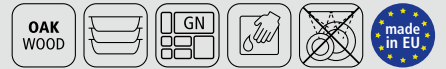

	cm	↑ cm	GN	Farbe / colour	€
14000	53 x 32,5	4,5	1/1	(oiled)	76,00
14001	53 x 32,5	8,5	1/1	(oiled)	92,00
14002	53 x 32,5	16,5	1/1	(oiled)	136,00
14100 <small>NEW</small>	53 x 32,5	4,5	1/1	(lacquered)	84,00
14101 <small>NEW</small>	53 x 32,5	8,5	1/1	(lacquered)	100,00
14102 <small>NEW</small>	53 x 32,5	16,5	1/1	(lacquered)	148,00





GN 1/2 Holzbox „VALO“

GN 1/2 woodbox  
GN 1/2 caja madera  
GN 1/2 base bois



	cm	↑ cm	GN	Farbe / colour	€
14003	32,5 x 26,5	4,5	1/2	(oiled)	54,00
14004	32,5 x 26,5	8,5	1/2	(oiled)	66,00
14005	32,5 x 26,5	16,5	1/2	(oiled)	92,00
14103 <b>NEW</b>	32,5 x 26,5	4,5	1/2	(lacquered)	59,00
14104 <b>NEW</b>	32,5 x 26,5	8,5	1/2	(lacquered)	72,00
14105 <b>NEW</b>	32,5 x 26,5	16,5	1/2	(lacquered)	100,00

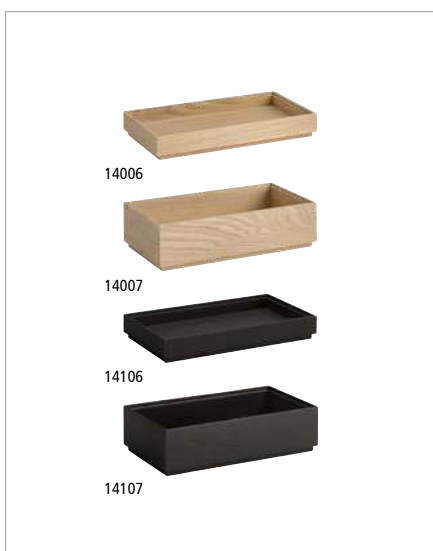

GN 1/3 Holzbox „VALO“

GN 1/3 woodbox  
GN 1/3 caja madera  
GN 1/3 base bois



	cm	↑ cm	GN	Farbe / colour	€
14006	32,5 x 17,6	4,5	1/3	(oiled)	46,00
14007	32,5 x 17,6	8,5	1/3	(oiled)	54,00
14106 <b>NEW</b>	32,5 x 17,6	4,5	1/3	(lacquered)	50,00
14107 <b>NEW</b>	32,5 x 17,6	8,5	1/3	(lacquered)	59,00



GN 1/6 Holzbox „VALO“

GN 1/6 woodbox  
GN 1/6 caja madera  
GN 1/6 base bois



	cm	↑ cm	GN	Farbe / colour	€
14027	17,6 x 16,2	8,5	1/6	(oiled)	46,00
14127	17,6 x 16,2	8,5	1/6	(lacquered)	50,00



**GN 2/4 Holzbox „VALO“**

GN 2/4 woodbox  
GN 2/4 caja madera  
GN 2/4 base bois

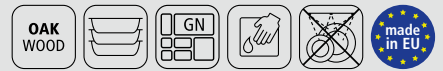

	cm	↑ cm	GN	Farbe / colour	€
14008	53 x 16,2	4,5	2/4	(oiled)	60,00
14009	53 x 16,2	8,5	2/4	(oiled)	71,00
14108 <span style="color:red">NEW</span>	53 x 16,2	4,5	2/4	(lacquered)	65,00
14109 <span style="color:red">NEW</span>	53 x 16,2	8,5	2/4	(lacquered)	78,00



**GN Naturschieferplatte**

GN natural slate tray  
GN bandeja de pizarra natural  
GN plat ardoise naturelle



**Schieferplatten mit möbelschonenden Füßchen – ideal als Auflage für GN Holzboxen**

slate trays with furniture-friendly feet – ideal as an overlay for GN wooden boxes

bandejas pizarra con pies protege-muebles – ideales como soporte para cajas de madera GN

plateaux en ardoise avec pieds protégé-meubles – idéals pour les caisses en bois GN

	cm	✦ mm	GN	€
01001	53,0 x 32,5	6-9	1/1	16,40
01003	32,5 x 26,5	6-9	1/2	9,20
01004	32,5 x 17,6	6-9	1/3	5,60
01002	53,0 x 16,2	6-9	2/4	6,80



**Einsatz für GN 1/1 Holzbox „VALO“**

insert for GN 1/1 woodbox  
separador para GN 1/1 caja madera  
insert pour GN 1/1 base bois



**Einsatz ergibt 15 Fächer (9,5 x 9,5 cm)**

insert creates 15 compartments (9,5 x 9,5 cm)

separador ofrece 15 compartimentos (9,5 x 9,5 cm)

insert donnant 15 compartiments (9,5 x 9,5 cm)

	cm	↑ cm	fits to	fits to	€
14021	50,5 x 30	6	GN 1/1	14001, 14101	36,00





### Einsatz für GN 1/2 Holzbox, 2er Set „VALO“

insert for GN 1/2 woodbox, set of 2  
 separador para GN 1/2 caja madera, set de 2  
 insert pour GN 1/2 base bois, set de 2

**Einsatz ergibt 3 Fächer, ideal für Besteck**

insert creates 3 compartments, ideal for cutlery  
 separador ofrece 3 compartimentos, ideal para cubiertos  
 insert donnant 3 compartiments, idéal pour les couverts



	cm	↑ cm	fits to	fits to	€/ set
14022	24 x 10,5	6	GN 1/2	14004, 14104	21,00



### Einsatz für GN Holzbox „VALO“

insert for GN woodbox  
 separador para GN caja madera  
 insert pour GN base bois

**passende Einsätze für GN Holzboxen, ideal zum Befüllen mit Crushed Eis**

suitable insert for GN wooden boxes, ideal for filling with crushed ice  
 bandeja para cajas de madera GN, ideal para rellenar con hielo picado  
 bac supérieur pour caisses en bois GN, idéal pour le remplissage avec de la glace pilée



	cm	↑ cm	GN	fits to	€
14041	51,5 x 31	6	1/1	14001, 14101	35,00
14036	51,5 x 31	14	1/1	14002, 14102	38,00
14042	31,0 x 25	6	1/2	14004, 14104	25,00
14037	31,0 x 25	14	1/2	14005, 14105	28,00
14043 <small>NEW</small>	51,5 x 15	6	2/4	14009, 14109	25,00

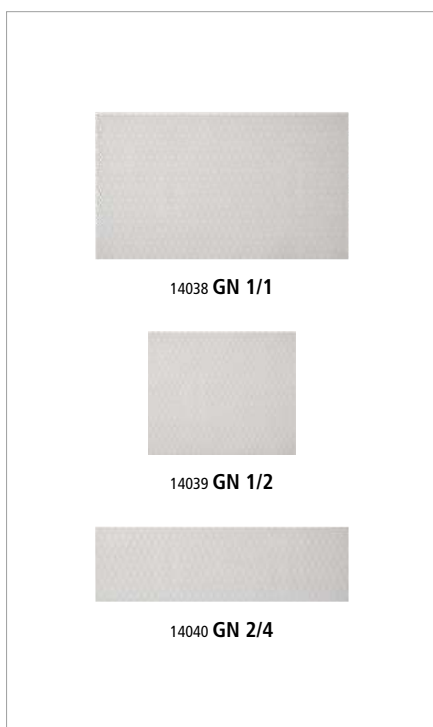

### Antirutschmatte für GN Holzbox „VALO“

anti-slip mat for GN woodbox  
 alfombra antideslizante para GN caja madera  
 tapis antidérapant pour GN base bois

**zur Einlage in GN Holzboxen, schützt das Holz vor fettenden oder ölhaltigen Lebensmitteln**

for insertion into GN wooden boxes, protects the wood from greasy or oily foods  
 para colocar en cajas de madera GN, protege la madera de alimentos grasos o aceitosos  
 a placer dans des caisses en bois GN, protège le bois des aliments gras ou huileux

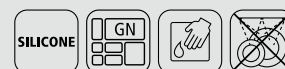

	cm	fits to	€
14038	50,4 x 30,0	GN 1/1	10,00
14039	30,0 x 24,1	GN 1/2	8,00
14040	50,4 x 13,8	GN 2/4	8,00

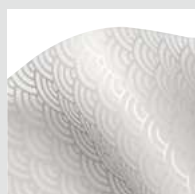

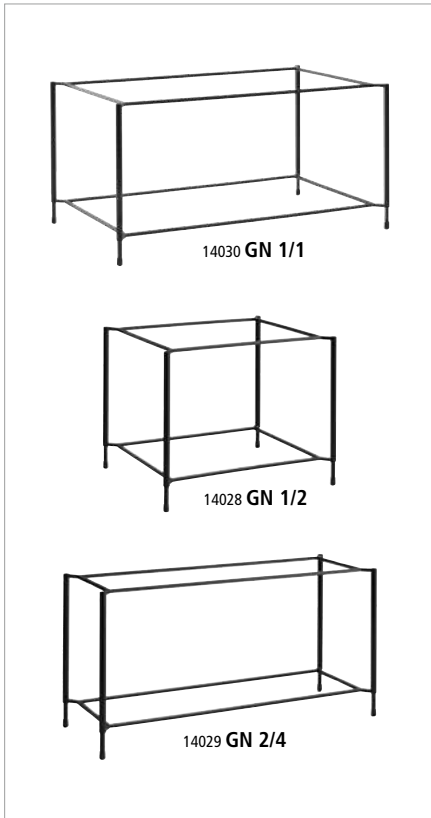

**GN Buffetständer „VALO“**

GN buffet stand  
GN soporte para buffet  
GN présentoir buffet



**multifunktionaler, stapelbarer Buffetständer aus pulverbeschichtetem Metall**

multifunctional, stackable buffet stand made of powder-coated metal  
soporte multifuncional apilable para buffet fabricado en metal con recubrimiento en polvo  
support de buffet multifonctionnel empilable en métal revêtu par poudre

	cm	↑ cm	GN	€
14030	57,0 x 37	28,5	1/1	160,00
14028 <b>NEW</b>	36,5 x 31	28,5	1/2	140,00
14029 <b>NEW</b>	57,0 x 21	28,5	2/4	140,00

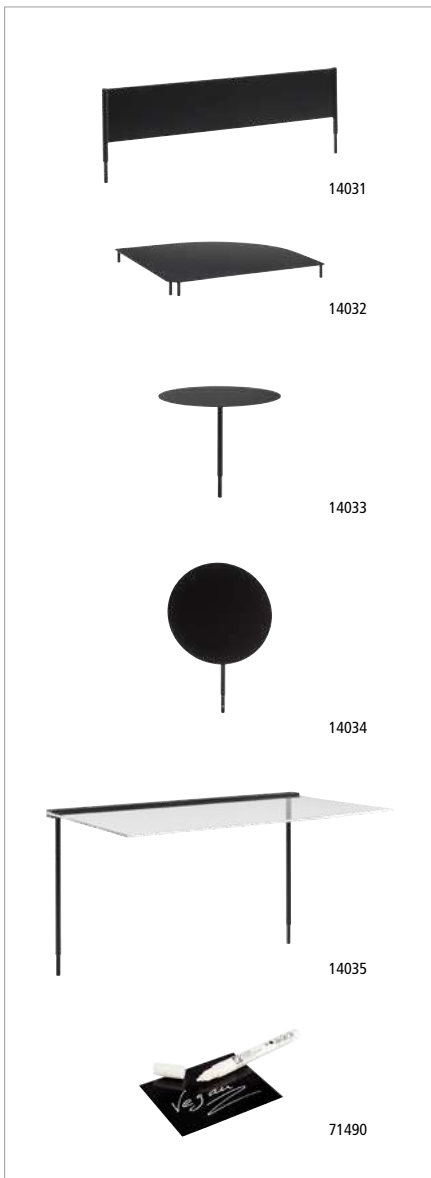

**Buffetständer Zubehör „VALO“**

buffet stand accessories  
accesorios para soportes de buffet  
accessoires pour présentoirs de buffet



**multifunktionales Zubehör aus pulverbeschichtetem Metall:**

• Stecktafel (beschriftbar) • Eckverbindung • Podest • Schild (beschriftbar) • Hygieneschutz

multifunctional accessories made of powder-coated metal:

• pegboard • corner connection • pedestal • shield • hygienic protection

accesorios multifuncionales de metal con recubrimiento en polvo:

• tablero de anuncios • conexión de esquina • pedestal • escudo • protección higiénica

accessoires multifonctionnels en métal thermolaqué:

• panneau d'affichage • raccord d'angle • plateforme • bouclier • protection hygiénique

	cm	↑ cm	fits to	€
14031	57,0 x 1,0	19,5	14029, 14030	38,00
14032	39,0 x 39,0	3,0	14028, 14030	56,00
14033	Ø 25	20,5	14028, 14029, 14030	30,00
14034	Ø 25	33,0	14028, 14029, 14030	30,00
14035	60,5 x 36,5	33,5	14029, 14030	130,00

**Kreidemarker, 2er Set**

chalk marker, set of 2  
rotulador de tiza, set de 2  
marqueur a la craie liquide, set de 2



	Ø cm	↑ cm	Farbe / colour	pcs.	€ / set
71490	1	13		2	6,50



2 tlg.  
2 pcs.

14050



14150

**Induktionsstation, 2-tlg. Set „VALO“**

induction station, 2-piece set  
estación de inducción, set de 2 piezas  
station à induction, set de 2 pièces

**2-teiliges Set, bestehend aus:**

- 1 Induktionskochplatte inklusive Kabelfernbedienung, Leistung in Stufen regelbar
- 1 Rahmen (wasserfest lackiert)

2 pcs., consisting of:

- 1 induction hotplate including cable remote control, power adjustable in steps
- 1 frame (waterproof lacquered)

set de 2, compuesto por:

- 1 placa de inducción con mando a distancia con cable, potencia regulable por niveles
- 1 marco (barnizado resistente al agua)

set de 2, composé de :

- 1 plaque à induction avec télécommande filaire, puissance réglable par paliers
- 1 cadre (vernis imperméable)

	cm	↑ cm		Farbe / colour	€
14050	38,5 x 38,5	10	2000 W		300,00
14150 <small>NEW</small>	38,5 x 38,5	10	2000 W		310,00



Kabelfernbedienung  
cable remote control

4 tlg.  
4 pcs.**Induktionsstation, 4-tlg. Set „VALO“**

induction station, 4-piece set  
estación de inducción, set de 4 piezas  
station à induction, set de 4 pièces

**4 teiliges Set:**

- 1 Induktionskochplatte inklusive Kabelfernbedienung (Ø 24 cm, 900 Watt)
- 1 Metallständer schwarz
- 1 Rahmen (wasserfest lackiert)
- 1 Edelstahlrahmen

4 pcs. set:

- 1 induction hotplate including cable remote control (Ø 24 cm, 900 watt)
- 1 metal stand black
- 1 frame (waterproof lacquered)
- 1 stainless steel frame

set de 4:

- 1 placa de inducción con mando a distancia con cable (Ø 24 cm, 900 vatios)
- 1 soporte de metal negro
- 1 marco (barnizado resistente al agua)
- 1 marco de acero inoxidable

set de 4:

- 1 plaque à induction avec télécommande filaire (Ø 24 cm, 900 watts)
- 1 support métallique noir
- 1 cadre (vernis imperméable)
- 1 cadre en acier inox

	cm	↑ cm		€
12275	35,4 x 32,5	19	900 W	250,00

**Ersatzteile / replacement parts / piezas de repuesto / pièces de rechange**

	cm	↑ cm		€
12276	35,4 x 32,5	8,5	Holzrahmen / wooden frame	80,00
12272	29,5 x 26,5	1	Edelstahlrahmen / stainless steel frame	22,00
12295	Ø 24	-	900 Watt Induktionskochplatte / induction plate	139,00
15506	35,4 x 32,5	17,6	Buffetständer schwarz / buffet stand black	25,00

NEW



14024



**Buffetgestell für GN Holzboxen „VALO“**

buffet stand for GN wooden boxes  
 soporte para buffet para cajas de madera GN  
 présentoir buffet pour caisses en bois GN  
**multifunktionales Gestell, kombinierbar mit GN Holzboxen**  
 multifunctional rack, can be combined with GN wooden boxes  
 estructura multifuncional, combinable con cajas de madera GN  
 support multifonctionnel, combinable avec des caisses en bois GN



	cm	↑ cm	fits to	€
14024	55,5 x 32	32	GN wooden boxes	174,00

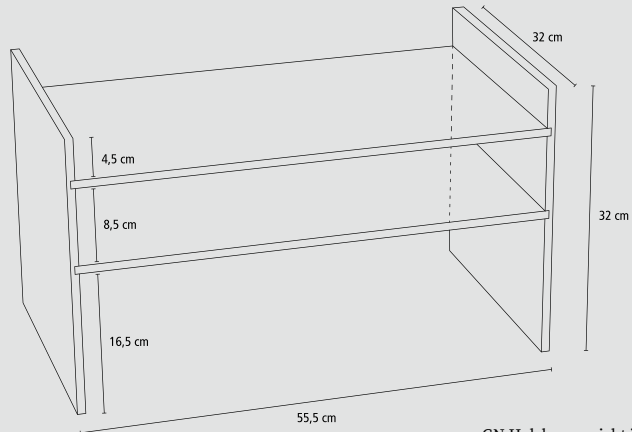

GN Holzboxen nicht im Lieferumfang enthalten  
 GN wooden boxes not included in delivery



01002  
**1x GN 2/4**



14009  
**1x GN 2/4**



14008  
**1x GN 2/4**



14004  
**2x GN 1/2**



14002  
**1x GN 1/1**

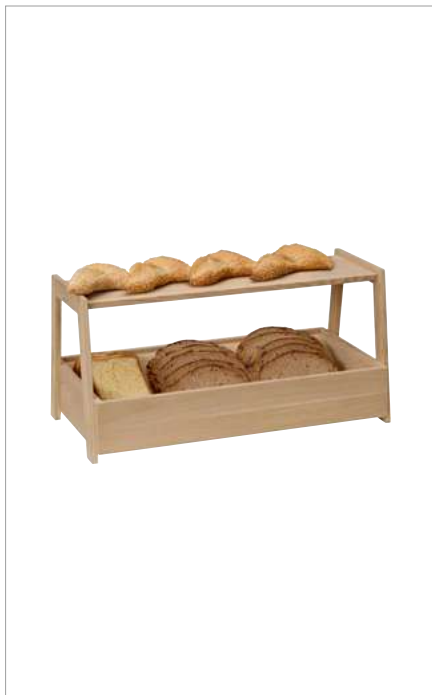

### Etagère, 2-stufig „VALO“

2-tier tray  
bandeja 2 alturas  
étagère carré 2 hauteurs

untere Ebene 52 x 26,5 cm, obere Ebene 52 x 16 cm

lower level 52 x 26,5 cm, upper level 52 x 16 cm

nivel inferior 52 x 26,5 cm, nivel superior 52 x 16 cm

niveau inférieur 52 x 26,5 cm, niveau supérieur 52 x 16 cm



	cm	↑ cm	€
14020	54 x 26,5	26,5	189,00



angewinkelte Innenbox  
für ideale Präsentation  
angled inner box  
for ideal presentation



### GN 1/1 Brotschneidebrett „VALO“

GN 1/1 cutting board  
GN 1/1 tabla de cortar  
planche à découper GN 1/1

massives Brotschneidebrett mit Antirutschfüßchen für sicheren Halt

solid cutting board with non-slip feet for a secure hold

tabla de cortar pan maciza con pies antideslizantes para una sujeción segura

planche à découper massive avec pieds antidérapants pour une bonne stabilité



	cm	↑ cm	GN	€
00764	53 x 32,5	3,5	1/1	100,00



### Brotmesser

bread knife  
cuchillo para pan  
couteau à pain

Brotmesser aus rostfreiem Edelstahl, dreifach genietet, mit Griff aus Buchenholz

bread knife made of stainless steel, triple riveted, with beech wood handle

cuchillo para pan de acero inoxidable, triple remachado, con mango de madera de haya

couteau à pain en acier inox, triplement riveté, avec manche en bois de hêtre



	→ cm	€
88990	34	16,00

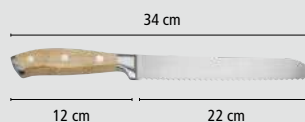



**Etagère, 3-stufig „VALO“**

3-tier tray  
bandeja 3 alturas  
étagère carré 3 hauteurs

**untere Ebene GN 1/1, mittlere Ebene 53 x 26,5 cm, obere Ebene GN 2/4**

lower level GN 1/1, middle level 53 x 26,5 cm, upper level GN 2/4

nivel inferior GN 1/1, nivel medio 53 x 26,5 cm, nivel superior GN 2/4

niveau inférieur GN 1/1, niveau intermédiaire 53 x 26,5 cm, niveau supérieur GN 2/4



	cm	↑ cm	fits to	€
14012	55,5 x 32,5	64	GN 1/1, 2/4	248,00



**Etagère, 2-stufig „VALO“**

2-tier tray  
bandeja 2 alturas  
étagère carré 2 hauteurs

**untere Ebene 53 x 26,5 cm, obere Ebene GN 2/4**

lower level 53 x 26,5 cm, upper level GN 2/4

nivel inferior 53 x 26,5 cm, nivel superior GN 2/4

niveau inférieur 53 x 26,5 cm, niveau supérieur GN 2/4



	cm	↑ cm	fits to	€
14011	55,5 x 26,5	44,5	GN 2/4	190,00



**Etagère, 2-stufig „VALO“**

2-tier tray  
bandeja 2 alturas  
étagère carré 2 hauteurs

**untere Ebene GN 1/2, obere Ebene GN 1/3**

lower level GN 1/2, upper level GN 1/3

nivel inferior GN 1/2, nivel superior GN 1/3

niveau inférieur GN 1/2, niveau supérieur GN 1/3



	cm	↑ cm	fits to	€
14010	35,0 x 26,5	44,5	GN 1/2, 1/3	164,00



**Etagère, 3-stufig „VALO“**

3-tier tray  
bandeja 3 alturas  
étagère carré 3 hauteurs

**untere Ebene Ø 30 cm, mittlere Ebene Ø 25 cm, obere Ebene Ø 17 cm**

lower level Ø 30 cm, middle level Ø 25 cm, upper level Ø 17 cm

nivel inferior Ø 30 cm, nivel medio Ø 25 cm, nivel superior Ø 17 cm

niveau inférieur Ø 30 cm, niveau intermédiaire Ø 25 cm, niveau supérieur Ø 17 cm



	Ø cm	↑ cm		€
14014	30	42		87,00



**Etagère, 2-stufig „VALO“**

2-tier tray  
bandeja 2 alturas  
étagère carré 2 hauteurs

**untere Ebene Ø 30 cm, obere Ebene Ø 25 cm**

lower level Ø 30 cm, upper level Ø 25 cm

nivel inferior Ø 30 cm, nivel superior Ø 25 cm

niveau inférieur Ø 30 cm, niveau supérieur Ø 25 cm



	Ø cm	↑ cm		€
14013	30	28		68,00



### Serviertablett „VALO“

tray  
bandeja  
plateau



**Innenmaß 56 x 36 cm, kombinierbar mit dem Tablettständer Nr. 14061**

inside dimension 56 x 36 cm, can be combined with tray stand no. 14061

dimension interior 56 x 36 cm, combinable con el soporte para bandejas no. 14061

dimension intérieure 56 x 36 cm, combinable avec le support pour plateau no. 14061

	cm	↑ cm	fits to	€
14060	60 x 40	3	14061	82,00



### Tablettständer „VALO“

tray stand  
soporte para bandejas  
support de plateau



**zusammenklappbar, kombinierbar mit dem Serviertablett Nr. 14060, Tragfähigkeit: 50 kg**

collapsible, can be combined with serving tray no. 14060, load capacity: 50 kg

plegable, combinable con la bandeja de servicio no. 14060, capacidad de carga: 50 kg

pliable, combinable avec le plateau de service no. 14060, capacité de charge: 50 kg

	cm	↑ cm	fits to	€
14061	56 x 35,5	75	14060	130,00



mit Magnetbefestigung  
with magnetic attachment





NEW

**Frischhaltehaube „VALO“**

cover  
campana  
cloche



stilvoll abgedeckt und geschützt – passend für Servier- und Tortenplatten Nr. 14095 & 14096  
 stylishly covered and protected – compatible with cake stands no. 14095 & 14096  
 elegante y protegida – compatible con porta pasteles no. 14095 & 14096  
 couverts et protégés avec style – compatible avec présentoir à gâteaux no. 14095 & 14096

	Ø cm	↑ cm	fits to	€
14097	30	16	14095, 14096, 19044, 19084	35,00



NEW

**Teller „THE GRID“**

plate  
plato  
assiette



	Ø cm	↑ cm	fits to	Farbe / colour	€
19044	32,0	2,5	14097	sand	36,00
19084	32,0	2,5	14097	mud	36,00



NEW



### Servier- und Tortenplatte „VALO“

cake stand  
porta pasteles  
présentoir à gâteaux

für eine stilvolle Präsentation von Kuchen und Gebäck, Ø Standfuß: 12 cm

for a stylish presentation of cakes and pastries, Ø base: 12 cm

presentación elegante de pasteles y repostería, Ø base: 12 cm

présentation élégante de gâteaux et pâtisseries, Ø socle: 12 cm



	Ø cm	↑ cm	fits to	Farbe / colour	€
14095	32	8,5	14097	(oiled)	89,00



NEW



### Servier- und Tortenplatte „VALO“

cake stand  
porta pasteles  
présentoir à gâteaux

für eine stilvolle Präsentation von Kuchen und Gebäck, Ø Standfuß: 15 cm

for a stylish presentation of cakes and pastries, Ø base: 15 cm

presentación elegante de pasteles y repostería, Ø base: 15 cm

présentation élégante de gâteaux et pâtisseries, Ø socle: 15 cm



	Ø cm	↑ cm	fits to	Farbe / colour	€
14096	32	17	14097	(oiled)	99,00



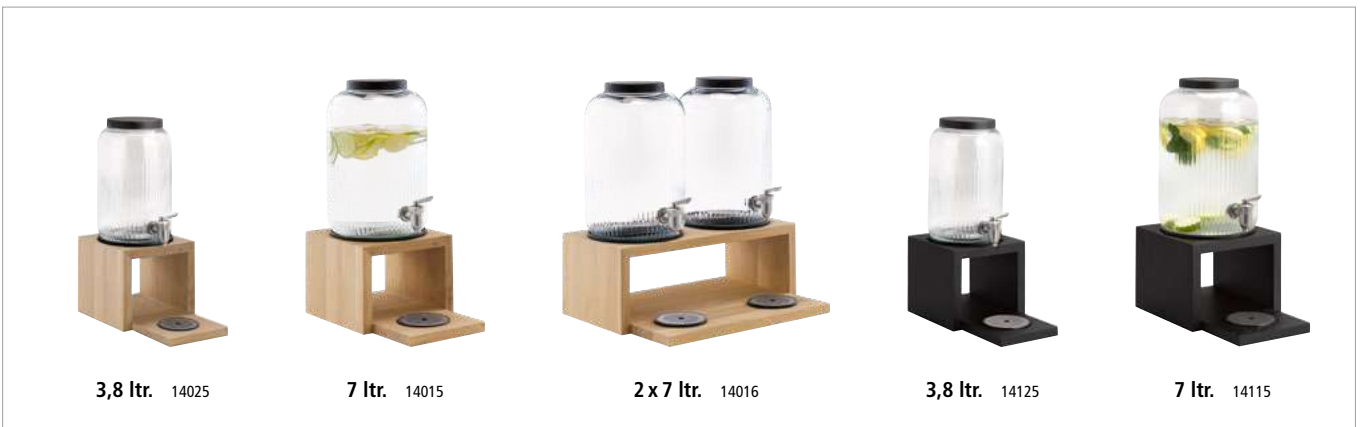

**Getränkespender „VALO“**

beverage dispenser  
dispensador de bebidas  
distributeur de boissons

Podest wasserfest lackiert, Zapfhahn aus Edelstahl,  
Untersetzer aus Melamin, Bodenplatte (Gläserntablett) herausnehmbar

platform waterproof lacquered, stainless steel tap,  
melamine coaster, removeable base plate

podio con barniz impermeable, grifo de acero inoxidable,  
posavasos de melamina, placa base extraíble

podium verni imperméable, robinet en acier inox,  
dessous de verre en mélamine, plaque de fond amovible



	cm	↑ cm	ltr.	Farbe / colour	€
14025	18,0 x 18,0	41,0	3,8		200,00
14015	21,0 x 21,0	46,5	7,0		240,00
14016	43,5 x 21,0	46,5	2x 7,0		390,00
14125 <b>NEW</b>	18,0 x 18,0	41,0	3,8		220,00
14115 <b>NEW</b>	21,0 x 21,0	46,5	7,0		260,00



### Eiswasserröhre

ice cube cooling tube  
tubo enfriador para cubitos  
tube pour glaçons



	Ø cm	↑ cm	fits to	€
10849	11	23	14015, 14016, 14025, 14115, 14125	9,40



10725  
0,5 ltr.

10726  
1,0 ltr.

10727  
1,5 ltr.

### Glaskaraffe „LINES“

glass carafe  
jarra de vidrio  
carafe en verre



ideal für Cerealien, Säfte oder Milch, Deckel aus Kork

ideal for cereals, juices or milk, cork lid

ideal para cereales, zumos o leche, tapa de corcho

idéal pour les céréales, les jus de fruits ou le lait, couvercle en liège

	Ø cm	↑ cm	ltr.	fits to	€
10725	9	19,5	0,5	14023, 14070, 14075, 14077, 14123, 14170	15,00
10726	9	27,5	1,0	14023, 14070, 14075, 14077, 14123, 14170	21,00
10727	9	35,0	1,5	14023, 14070, 14075, 14077, 14123, 14170	22,00





**Glaskaraffe „LINES“**

glass carafe  
jarra de vidrio  
carafe en verre

GLASS CORK

ideal für Cerealien, Säfte oder Milch, Deckel aus Kork

ideal for cereals, juices or milk, cork lid

ideal para cereales, zumos o leche, tapa de corcho

idéal pour les céréales, les jus de fruits ou le lait, couvercle en liège

	Ø cm	↑ cm	ltr.	fits to	€
10725	9	19,5	0,5	14023, 14123	15,00
10726	9	27,5	1,0	14023, 14123	21,00
10727	9	35,0	1,5	14023, 14123	22,00



**3er-Podest für Glaskaraffen „VALO“**

podest for 3 glass carafes  
pedestal para 3 jarras de vidrio  
podium pour 3 pichets en verre

OAK WOOD

ideal für eine stets geordnete Präsentation am Buffet

ideal for a constantly organised presentation at the buffet

ideal para una presentación constantemente organizada en el buffet

idéal pour une présentation toujours ordonnée au buffet

	cm	↑ cm	fits to	Farbe / colour	€
14023	41 x 16	12	10725, 10726, 10727, 10735	oiled	49,00
14123	41 x 16	12	10725, 10726, 10727, 10735	lacquered	54,00



0,75 ltr.

**Glaskaraffe „LINES“**

glass carafe  
jarra de vidrio  
carafe en verre

GLASS

CORK

**ideal für Cerealien, Säfte oder Milch, Deckel aus Kork**

ideal for cereals, juices or milk, cork lid

ideal para cereales, zumos o leche, tapa de corcho

idéal pour les céréales, les jus de fruits ou le lait, couvercle en liège

	Ø cm	↑ cm	ltr.	fits to	€
10738	8	28	0,75	14019	20,00

**1er-Podest für Glaskaraffen „VALO“**

podest for 1 glass carafe  
pedestal para 1 jarra de vidrio  
podium pour 1 pichet en verre

OAK  
WOOD**ideal für eine stets geordnete Präsentation am Buffet**

ideal for a constantly organised presentation at the buffet

ideal para una presentación constantemente organizada en el buffet

idéal pour une présentation toujours ordonnée au buffet

	cm	↑ cm	fits to	€
14019	15 x 15	12	10738	15,00

**Serviettenhalter „VALO“**

napkin holder  
servilletero  
porte-serviettes

OAK  
WOOD

METAL

**für ca. 100 Servietten mit 1/4 Falz, inklusive Beschwerer**

for approx. 100 napkins with 1/4 fold, including weight

para aprox. 100 servilletas con 1/4 de pliegue, con barra de contrapeso

pour env. 100 serviettes pliées en 1/4, avec barre de contrepois

	cm	↑ cm	€
14092	19 x 19	16	59,00

**Table Caddy „VALO“**

table caddy  
caddy de mesa  
caddy de table

OAK  
WOOD

METAL

**2 Fächer: 6 x 6 cm / 1 Fach: 6 x 13 cm**

2 compartments: 6 x 6 cm / 1 compartment: 6 x 13 cm

2 compart. 6 x 6 cm, 1 compart. 6 x 13 cm

2 compart. 6 x 6 cm, 1 compart. 6 x 13 cm

	cm	↑ cm	€
14090	15 x 15	28	72,00

**Table Caddy „VALO“**

table caddy  
caddy de mesa  
caddy de table

OAK  
WOOD**2 Fächer: 6 x 6 cm / 1 Fach: 6 x 13 cm**

2 compartments: 6 x 6 cm / 1 compartment: 6 x 13 cm

2 compart. 6 x 6 cm, 1 compart. 6 x 13 cm

2 compart. 6 x 6 cm, 1 compart. 6 x 13 cm

	cm	↑ cm	€
14091	15 x 15	31	84,00

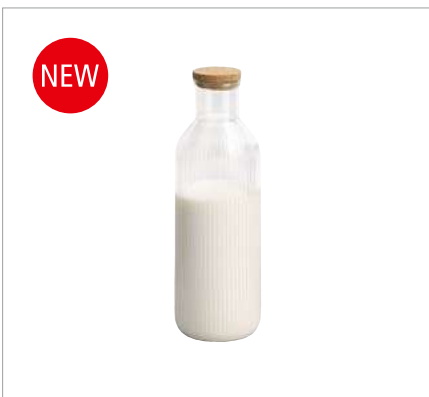

**Glaskaraffe „LINES“**

glass carafe  
jarra de vidrio  
carafe en verre

GLASS CORK

ideal für Milch oder Säfte, Deckel aus Kork  
ideal for milk or juices, cork lid  
ideal para leche o zumos, tapa de corcho  
idéal pour le lait ou les jus de fruits, couvercle en liège

	Ø cm	↑ cm	ltr.	fits to	€
10735	9	27	1	10736, 14023, 14123	21,00



**Labelclips, 4er Set**

label clips, set of 4  
etiqueta clip, set de 4  
étiquette clip, set de 4

STAINLESS STEEL

vier verschiedene Beschriftungen (milk, oat, almond, soy) – passend für Glaskaraffe Nr. 10735  
four different labels (milk, oat, almond, soy) – suitable for glass carafe no. 10735  
cuatro etiquetas diferentes (milk, oat, almond, soy) – aptas para jarra de cristal no. 10735  
quatre inscriptions différentes (milk, oat, almond, soy) – pour la carafe en verre no. 10735

	Ø cm	↑ cm	fits to	pcs.	€ / set
10736	4,5	2,5	10735	4	8,80

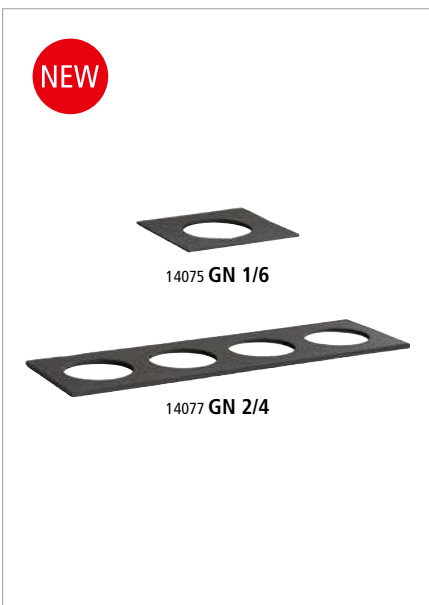

**GN Naturschieferplatte**

GN natural slate tray  
GN bandeja de pizarra natural  
GN plat ardoise naturelle

SLATE GN

Schieferplatte mit Ausschnitt (Ø 10,5 cm) – passend für Glaskaraffe Nr. 10735  
slate plate with cut-out (Ø 10,5 cm) – suitable for glass carafe no. 10735  
placa de pizarra con recorte (Ø 10,5 cm) – apta para jarra de cristal no. 10735  
plaque d'ardoise avec découpe (Ø 10,5 cm) – pour la carafe en verre no. 10735

	cm	✂ mm	GN	fits to	€
14075	17,6 x 16,2	6-9	1/6	14027, 14127	4,20
14077	53,0 x 16,2	6-9	2/4	14009, 14109	11,00



NEW



## GN 1/6 Naturschieferplatte

GN 1/6 natural slate tray  
GN 1/6 bandeja de pizarra natural  
GN 1/6 plat ardoise naturelle



Schieferplatte mit Ausschnitt (8,3 x 8,3 cm) – passend für handelsübliche Milch- oder Saftkartons

slate plate with cut-out (8,3 x 8,3 cm) – suitable for standard milk or juice cartons

placa de pizarra con recorte (8,3 x 8,3 cm) – para envases estándar de leche o zumo

plaque en ardoise avec découpe (8,3 x 8,3 cm) – pour briques de lait ou de jus standard

	cm	✂ mm	GN	fits to	€
14076	17,6 x 16,2	6-9	1/6	14027, 14127	4,20



NEW



14070



14170

## GN 1/6 Kühlbox, 4-tlg. Set „VALO“

GN 1/6 cool box, 4-piece set  
GN 1/6 nevera portátil, set de 4 piezas  
GN 1/6 glacière, set de 4 pièces



4-teiliges Set, bestehend aus:

- 1 GN 1/6 Holzbox, 1 Einsatz aus EPP, 1 Kühlakku aus PE, 1 GN 1/6 Naturschieferplatte mit Ausschnitt (Ø 10,5 cm)

4 pcs., consisting of:

- 1 GN 1/6 woodbox, 1 insert made of EPP, 1 cooling pack made of PE, 1 GN 1/6 natural slate plate with cut-out (Ø 10,5 cm)

set de 4, compuesto por:

- 1 caja de madera GN 1/6, 1 inserto de EPP, 1 acumulador de frío de PE, 1 placa de pizarra natural GN 1/6 con recorte (Ø 10,5 cm)

set de 4, composé de:

- 1 boîte en bois GN 1/6, 1 insert en EPP, 1 accumulateur de froid en PE, 1 plaque en ardoise naturelle GN 1/6 avec découpe (Ø 10,5 cm)

	cm	↑ cm	GN	Farbe / colour	€
14070	17,6 x 16,2	9	1/6	(oiled)	64,00
14170	17,6 x 16,2	9	1/6	(lacquered)	69,00



10662



10791

## Kühlakku

cooler  
acumulador de frío  
accumulateur de froid



	cm	↑ cm	fits to	€
10662 <small>NEW</small>	Ø 10,5	2,0	14079	3,40
10791	25 x 19	2,5	14078	8,40

NEW



14079



14078

## Einsatz „VALO“

insert  
inserto  
insert



	cm	↑ cm	fits to	€
14079	14 x 12,5	5	GN 1/6, GN 2/4	12,00
14078	30 x 24,0	4	GN 1/2, GN 1/1	13,00

# VALUMO



# VALUMO – Ihr Buffet, perfekt beleuchtet. Kabellos. Flexibel. Stilvoll.

VALUMO – Your buffet, perfectly illuminated.  
Wireless. Flexible. Stylish.

Das Buffet-Beleuchtungssystem VALUMO überzeugt durch seine Kombination aus modernem Design und praktischer Funktionalität. Es besteht aus den Leuchtköpfen Nr. 17090 & 17096 und fünf flexiblen Halterungen. Dank der Magnetkugelbefestigung lässt sich der Leuchtkopf nahezu 360 Grad drehen, um das Licht präzise auszurichten.

Die Steuerung erfolgt ganz bequem über eine Fernbedienung oder direkt über den Touch-Button am Gehäuse. Mit Kaltweiß, Warmweiß und RGB-Farben bietet VALUMO vielfältige Beleuchtungsoptionen für jede Stimmung und jeden Anlass.

Der Leuchtkopf wird über die mitgelieferte Ladeplatte oder die optional erhältlichen Mehrfach-Ladeplatten aufgeladen – eine Lösung, die kabellosen Komfort und maximale Flexibilität garantiert.

VALUMO ist die ideale Ergänzung für jedes Buffet und eignet sich perfekt für unser Buffetsystem VALO. Es lässt sich nahtlos integrieren und flexibel kombinieren, um individuellen Anforderungen gerecht zu werden.

The VALUMO buffet lighting system impresses with its combination of modern design and practical functionality. It consists of the light heads no. 17090 & 17096 and five flexible brackets. Thanks to the magnetic ball attachment, the light head can be rotated almost 360 degrees to precisely align the light.

It can be conveniently controlled via a remote control or directly via the touch button on the housing. With cool white, warm white and RGB colours, VALUMO offers a wide range of lighting options for every mood and occasion.

The light head is charged via the supplied charging plate or the optionally available multiple charging plates - a solution that guarantees wireless convenience and maximum flexibility.

VALUMO is the ideal addition to any buffet and the perfect complement to our VALO buffet system. It integrates seamlessly and can be flexibly combined to meet individual requirements.



Magnetkugelbefestigung  
magnetic ball mounting



nahezu 360 Grad drehbar  
almost 360 degrees rotatable



Ladestation  
charging station



**NEW**



Ø 10 cm



**Leuchtkopf**  
light head  
cabezal luminoso  
tête lumineuse



**inklusive Ladestation, USB Ladekabel (ohne Netzteil), Fernbedienung inklusive Batterie**  
charging station included, USB charging cable (without mains adapter), remote control including battery  
con estación de carga, cable de carga USB (sin adaptador de red), mando a distancia con pila incluida  
avec station de charge, câble de charge USB (sans bloc d'alimentation), télécommande incluse pile

	Ø cm	↑ cm	€
17096	10,0	4,5	34,00



Ø 7,5 cm



**Leuchtkopf**  
light head  
cabezal luminoso  
tête lumineuse



**inklusive Ladestation, USB Ladekabel (ohne Netzteil), Fernbedienung inklusive Batterie**  
charging station included, USB charging cable (without mains adapter), remote control including battery  
con estación de carga, cable de carga USB (sin adaptador de red), mando a distancia con pila incluida  
avec station de charge, câble de charge USB (sans bloc d'alimentation), télécommande incluse pile

	Ø cm	↑ cm	€
17090	7,5	5,0	30,00



**2er Standfuß inklusive Stab „VALUMO“**

2-piece stand including rod  
soporte de 2 con varilla incluida  
piéd de 2 avec tige incluse

**bestehend aus 3 Elementen: Standfuß mit Stab, Erweiterungsstab, Magnetkugeln**

consisting of 3 elements: stand with rod, extension rod, magnetic spheres  
compuesto por 3 elementos: soporte con varilla, varilla de prolongación, esferas magnéticas  
composé de 3 éléments : pied avec tige, tige de rallonge, boules magnétiques

METAL

	∅ cm	↑ cm	€
17095	17	31 - 51	24,00



**1er Standfuß inklusive Stab „VALUMO“**

stand including rod  
soporte con varilla incluida  
piéd de support, tige incluse

**bestehend aus 3 Elementen: Standfuß mit Stab, Erweiterungsstab, Magnetkugel**

consisting of 3 elements: stand with rod, extension rod, magnetic sphere  
compuesto por 3 elementos: soporte con varilla, varilla de prolongación, esfera magnética  
composé de 3 éléments : pied avec tige, tige de rallonge, boule magnétique

METAL

	∅ cm	↑ cm	€
17092	14	31 - 51	20,00

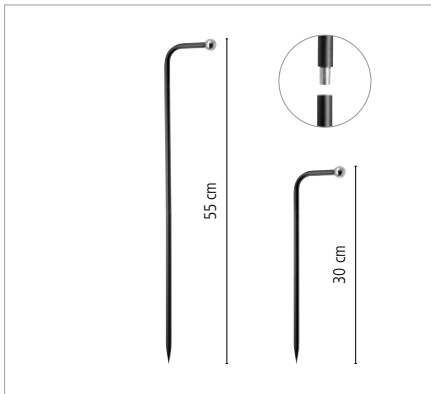

**Stab zum Stecken „VALUMO“**

stick for insertion  
varilla de inserción  
tige à enfoncer

**bestehend aus 3 Elementen: Spitze (24 cm), Erweiterungsstab, Magnetkugel**

consisting of 3 elements: tip (24 cm), extension rod, magnetic sphere  
compuesto por 3 elementos: punta (24 cm), varilla de prolongación, esfera magnética  
composé de 3 éléments : pointe (24 cm), tige de rallonge, boule magnétique

METAL

	∅ cm	↑ cm	fits to	€
17093	0,9	30 - 55	14028, 14029, 14030	9,00

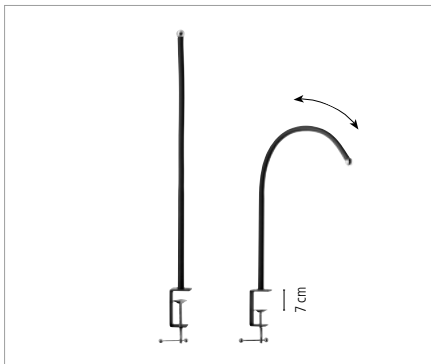

**Schraubklammer mit flexiblem Arm „VALUMO“**

screw clamp with flexible arm  
abrazadera de tornillo con brazo flexible  
pince à visser avec bras flexible

**zum Befestigen an Buffetelementen oder Tischplatten, mit flexiblem Arm**

for attachment to buffet elements or table tops, with flexible arm  
para fijar a elementos de buffet o tableros de mesa, con brazo flexible  
à fixer sur des éléments de buffet ou des plateaux de table, avec bras flexible

METAL

	cm	↑ cm	€
17094	4,5 x 4	64	19,00

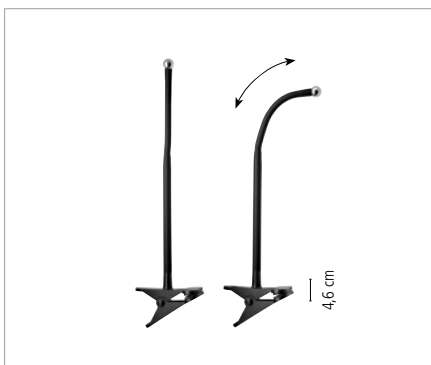

**Klammer mit flexiblem Arm „VALUMO“**

clamp with flexible arm  
pinza con brazo flexible  
agrafe avec bras flexible

**zum einfachen Befestigen an Buffetelementen oder Tischplatten, mit flexiblem Arm**

for easy attachment to buffet elements or table tops, with flexible arm  
para fijar fácilmente a elementos de buffet o tableros de mesa, con brazo flexible  
pour une fixation facile sur des éléments de buffet ou des plateaux de table, avec bras flexible

ABS

METAL

	cm	↑ cm	€
17091	11 x 7,5	40	16,00



## BRIDGE



### Kühlbox „BRIDGE“

refrigerated buffet display  
set de buffet refrigerado  
présentoir buffet froid



Set bestehend aus: 1 Gestell aus Ahorn oder Wenge, 1 Behälter aus Kunststoff, 1 GN1/1 Tablett aus Melamin, 1 Kühlakku, 1 Rolltophaube (fix montiert)

set consists of: 1 base element maple or wenge, 1 plastic insert black, 1 GN1/1 tray melamine, 1 cooler, 1 cover (fixed)

set compuesto por: 1 soporte de madera arce o wengué, 1 cubeta de plástico, 1 bandeja de melamina GN 1/1, 1 acumulador de frío, 1 campana rolltop (fija)

set composé de: 1 support en bois érable ou wengé, 1 bac plastique, 1 plat en mélamine GN 1/1, 1 accumulateur de froid, 1 cloche rolltop (fixe)

	cm	↑ cm	Farbe / colour	Holz / Wood	€
13990	63,5 x 42,5	31		Ahorn / maple	380,00
14990	63,5 x 42,5	31		Buche / beech	380,00



2 sizes  
0,50 ltr. / 2,50 ltr.

### Kühlschale „BRIDGE“

cooling bowl  
bol refrigerado  
bol réfrigéré



4-teilig: 1 Gestell aus Ahorn oder Wenge, 1 Behälter aus Edelstahl, 1 Schale aus Melamin (Ø 14 cm o. 23 cm), 1 Kühlakku

4 pcs.: 1 base element maple or wenge, 1 bowl stainless steel, 1 bowl melamine (Ø 14 or 23 cm), 1 cooler

set de 4: 1 soporte de madera arce o wengué, 1 cuenco de acero inoxidable, 1 cuenco de melamina (Ø 14 cm o 23 cm), 1 acumulador de frío

set de 4: 1 support en bois érable ou wengé, 1 bol en acier inox, 1 bol en mélamine (Ø 14 cm ou 23 cm), 1 accumulateur de froid

	cm	↑ cm	ltr.	Farbe / colour	€
14980	18,5 x 18,5	10	0,5		69,00
14981	27,5 x 27,5	14	2,5		130,00



### Besteckbehälter „BRIDGE“

cutlery organizer  
cajón para cubiertos  
bac à couverts



2 teiliges Set: 1 Gestell, 1 Besteckbehälter (Nr. 11955), herausnehmbar

2 pcs.: 1 base element, 1 removable plastic container (item 11955)

set de 2: 1 soporte, 1 cajón para cubiertos (ref. 11955) extraíble

set de 2: 1 support, 1 bac à couverts (réf. 11955) amovible

	cm	↑ cm	Farbe / colour		€
14995	57,7 x 37	12		Buche / beech	94,00



### Cerealienspender „BRIDGE“

cereal dispenser  
dispensador de cereales  
distributeur de céréales



Behälter herausnehmbar, „Feierabend-Deckel“ für das aromadichte Lagern, Portionieren durch einfaches Drehen

removable canister, special lid to keep the cereals fresh, easy to use, rotate the button to get the muesli

contenedor extraíble, tapa especial para mantener los cereales frescos, fácil de usar, se gira el pomo para servir los cereales

réceptacle amovible, couvercle spécial pour conserver les céréales, usage facile en tournant le bouton

	cm	↑ cm	ltr.	Farbe / colour	Holz / Wood	€
13987	21 x 20	55,5	4,5		Ahorn / maple	114,00
14987	21 x 20	55,5	4,5		Buche / beech	114,00



Milchdispenser „BRIDGE“

milk dispenser  
dispensador de leche  
distributeur à lait



Edelstahl Dispenser mit 1 Kühlakku im Standfuß inklusive touchless adapter

stainless steel dispenser with 1 cooling element in stand including touchless adapter  
dispensador de acero inoxidable con 1 acumulador de frío en la base y con adaptador sin contacto para grifo  
distributeur en acier inox avec 1 accumulateur de froid dans le socle et avec adaptateur sans contact manuel

	cm	↑ cm	ltr.	Farbe / colour	€
10836	31 x 20	39	3	Ahorn / maple	290,00



Milchdispenser „BRIDGE“

milk dispenser  
dispensador de leche  
distributeur à lait



Edelstahl Dispenser mit 1 Kühlakku im Standfuß inklusive touchless adapter

stainless steel dispenser with 1 cooling element in stand including touchless adapter  
dispensador de acero inoxidable con 1 acumulador de frío en la base y con adaptador sin contacto para grifo  
distributeur en acier inox avec 1 accumulateur de froid dans le socle et avec adaptateur sans contact manuel

	cm	↑ cm	ltr.	Farbe / colour	€
10837	31 x 20	39	3	Buche / beech	290,00



Saftdispenser „BRIDGE“

juice dispenser  
dispensador de zumo  
distributeur à jus



Kühlung durch 2 Kühlakkus von oben und unten

cooling with 2 cooling elements from the top and base  
2 acumuladores de frío: 1 en la base y 1 en la tapa  
2 accumulateurs de froid: 1 dans le couvercle et 1 dans le socle

	cm	↑ cm	ltr.	Farbe / colour	€
10870	31,0 x 20	42	4	Ahorn / maple	248,00
10871	35,5 x 22	50	6	Ahorn / maple	290,00



inklusive 3 Magnetschilder: ORANGE, APPLE, GRAPEFRUIT  
including 3 magnetic signs: ORANGE, APPLE, GRAPEFRUIT



Saftdispenser „BRIDGE“

juice dispenser  
dispensador de zumo  
distributeur à jus



Kühlung durch 2 Kühlakkus von oben und unten

cooling with 2 cooling elements from the top and base  
2 acumuladores de frío: 1 en la base y 1 en la tapa  
2 accumulateurs de froid: 1 dans le couvercle et 1 dans le socle

	cm	↑ cm	ltr.	Farbe / colour	€
10872	31,0 x 20	42	4	Buche / beech	248,00
10873	35,5 x 22	50	6	Buche / beech	290,00



inklusive 3 Magnetschilder: ORANGE, APPLE, GRAPEFRUIT  
including 3 magnetic signs: ORANGE, APPLE, GRAPEFRUIT



**Buffetgestell „TRIANGLE“**

buffet stand  
expositor de buffet  
présentoir buffet



**Buche massiv, 3 Ebenen: 1.: 53 x 19 cm, 2.: 40 x 17,5 cm, 3.: 30 x 15 cm**  
 beech maple, 3 levels: 1.: 53 x 19 cm, 2.: 40 x 17,5 cm, 3.: 30 x 15 cm  
 haya sólido, 3 niveles: 1.: 53 x 19 cm, 2.: 40 x 17,5 cm, 3.: 30 x 15 cm  
 hêtre massif, 3 niveaux: 1.: 53 x 19 cm, 2.: 40 x 17,5 cm, 3.: 30 x 15 cm

	cm	↑ cm	Farbe / colour	€
13966	53 x 21	50		145,00
14966	53 x 21	50		145,00



**Buffet Box „SEWING BASKET“**

buffet box  
caja de buffet  
boîte de buffet



**aus geöltem Eichenholz, 3 Fächer: 33 x 27 cm, H: 7 cm, passend für GN 1/2**  
 made of oiled oak wood, 3 compartments: 33 x 27 cm, H: 7 cm, suitable for GN 1/2  
 de madera de roble aceitada, 3 compartimentos: 33 x 27 cm, H: 7 cm, para GN 1/2  
 en bois de chêne huilé, 3 compartiments: 33 x 27 cm, H: 7 cm, pour GN 1/2

	cm	↑ cm	Farbe / colour	€
11711	36 x 29	28	natural oak	320,00

geschlossen | closed  
37 x 29 cm, H: 28 cm

geöffnet | open  
70,5 x 37 cm, H: 53,5 cm

# FRAMES



## Kühltablets SET 1 „FRAMES“

cooling plates  
bandejas refrigeradas  
plateaux réfrigérés



GN 1/1 Basis, GN 1/1 Edelstahl Tablett 18/10, Kühlakku

GN 1/1 base element, GN 1/1 stainless steel platter 18/10, cooler  
elemento básico GN 1/1, bandeja GN 1/1 de acero inoxidable 18/10, acumulador de frío  
élément de base GN 1/1, plateau GN 1/1 en acier inox 18/10, accumulateur de froid

	cm	↑ cm	GN	Farbe / colour	€
12940	53 x 32,5	8,5	1/1	stainless steel	246,00
14940	53 x 32,5	8,5	1/1	wenge wood	249,00



## Kühltablets SET 2 „FRAMES“

cooling plates  
bandejas refrigeradas  
plateaux réfrigérés



GN 1/1 Basiselement, GN 1/1 Edelstahl Tablett 18/10, Rolltophaube, Kühlakku

GN 1/1 base element, GN 1/1 stainless steel platter, rolltop cover, cooler  
elemento básico GN 1/1, bandeja GN 1/1 de acero inoxidable 18/10, campana rolltop, acumulador de frío  
élément de base GN 1/1, plateau GN 1/1 en acier inox 18/10, cloche rolltop, accumulateur de froid

	cm	↑ cm	GN	Farbe / colour	€
12941	53 x 32,5	27,5	1/1	stainless steel	310,00
14941	53 x 32,5	27,5	1/1	wenge wood	314,00



82355  
GN 1/1

GN Tablett „FRAMES“

GN tray  
GN bandeja  
GN plateau



	cm	↑ cm	GN	€
82355	53,0 x 32,5	2	1/1	46,00
82356	32,5 x 26,5	2	1/2	26,00



GN Edelstahl Tablett „FRAMES“

GN stainless steel platter  
GN bandeja acero inoxidable  
GN plateau acier inox



	cm	↑ cm	GN	€
11119	53,0 x 32,5	2	1/1	33,00



84046

84047

84048

GN Tablett „FRAMES“

GN tray  
GN bandeja  
GN plateau



	cm	↑ cm	GN	€
84046	53,0 x 32,5	2	1/1	33,00
84047	32,5 x 26,5	2	1/2	18,40
84048	32,5 x 17,6	2	1/3	12,60



GN Wanne „FRAMES“

GN tray  
GN bandeja  
GN plateau



	cm	↑ cm	GN	fits to	€
17922	53 x 32,5	8	1/1	12940, 14940	60,00

## FRAMES



### Korb „GN LINE“

GN basket  
GN cesta  
GN corbeille



**stabile Ausführung mit Edelstahldraht im Rand zur Stabilisierung**

very solid with stainless steel wire frame to stabilize the basket

muy resistente con alambre de acero inoxidable en el borde para la estabilización

très résistante avec fil d'acier inox dans le bord pour la stabilisation

	cm	↑ cm	GN	€
40291	53,0 x 32,5	6,5	1/1	26,00
40290	32,5 x 26,5	6,5	1/2	15,80
40293	53,0 x 32,5	10,0	1/1	31,40
40292	32,5 x 26,5	10,0	1/2	18,80



### Buffetkorb „ECONOMIC“

basket  
cesta  
corbeille



**Polyrattan, mit Haubenschiene (ohne Haube)**

polyrattan, with frame to fix the cover (without cover)

polyrattan, con fijación para campana (sin campana)

polyrattan, avec fixation pour la cloche (sans cloche)

	cm	↑ cm	€
40294	56,5 x 36,0	10	33,00



### Buffetkorb „ECONOMIC“

buffet basket  
cesta de buffet  
corbeille de buffet



**Polyrattan, mit Haubenschiene (ohne Haube)**

polyrattan, with frame to fix the cover (without cover)

polyrattan, con fijación para campana (sin campana)

polyrattan, avec fixation pour la cloche (sans cloche)

	Ø cm	↑ cm	€
40295	40	12,5	23,00



### Rolltophaube

rolltop cover  
campana abatible  
cloche basculante



	Ø cm	↑ cm	€
18389	38	20	23,00



### GN 1/1 Rolltophaube

GN 1/1 rolltop cover  
GN 1/1 campana abatible  
GN 1/1 cloche basculante



**patentiert, leichtgängig auf- und zuklappbar 90°**

patented, easy to open and close 90°

patentada, fácil de abrir y cerrar 90°

brevetée, facile à ouvrir et à fermer 90°

	cm	↑ cm	GN	€
11018	53 x 32,5	17	1/1	64,00



**Gestell für GN 1/1 „FRAMES“**

serving stand GN 1/1  
soporte para GN 1/1  
support pour GN 1/1

**Buche massiv, Wenge**  
solid beech, colour wenge  
haya maciza, color wengué  
hêtre massif, couleur wengé



	cm	↑ cm	€
14953	57,5 x 27,5	22	90,00



**Besteck- / Universal-Box, 2-teilig „FRAMES“**

cutlery tray, 2 pcs.  
cubertero o cajón multi-usos, set de 2  
caisson à couverts ou multi-usages, set de 2

**Buche massiv, Wenge, 4 Fächer, inklusive herausnehmbaren Einsatz**  
solid beech, colour wenge, 4 compartments, including removable insert  
haya maciza, color wengué, 4 compartimentos, con separador extraíble  
hêtre massif, couleur wengé, 4 compartiments, avec insert amovible



	cm	↑ cm	GN	€
14956	53 x 32,5	11	1/1	184,00

**Einsatz für GN 1/1 „FRAMES“ / insert for GN1/1 / separador para GN1/1 / insert pour GN1/1**

	cm	↑ cm	€
14954	48,5 x 28	8	44,00



**Eisbox „FRAMES“**

ice box  
bandeja para hielo  
caisse à glaçons

**3-teilig: 1 Basiselement Wenge + 1 Polystyrolwanne + 1 Tropfgitter**  
3 pcs. set: 1 box wenge + 1 plastic deep tray + 1 drainer plate  
set de 3: 1 cajón color wengué + 1 cubeta plástico + 1 rejilla  
set de 3: 1 caisson couleur wengé + 1 bac plastique + 1 plaque perforée



	cm	↑ cm	GN	€
14970	53 x 32,5	12,5	1/1	189,00

# SUPERBOX



Die stapelbaren Wendeboxen lassen sich rutschfest stapeln und mit flachen GN Platten verbinden und einzeln nutzen. Individuell können Buffet-landschaften gebaut werden.

The stackable and non-slip reversible boxes can be connected to flat GN trays and can also be used individually. Different and individual buffet sceneries can be built up.

Las cajas girables y apilables son antideslizantes y se pueden conectar con bandejas planas GN o utilizar individualmente. Se pueden construir diferentes paisajes de buffet muy individuales.

Les boîtes de tournage empilables sont antiglissantes et peuvent être connectées avec des plateaux plats GN ou utilisées individuellement. Des paysages de buffet très personnalisés peuvent être construits.



## GN 1/1 „SUPERBOX“



Akazienholz / acacia wood / madera de acacia / bois d'acacia

	cm	↑ cm	GN	Farbe / colour	€
11620	55,5 x 35,0	10,5	1/1		46,00
11626	55,5 x 35,0	10,5	1/1		46,00
11721	55,5 x 35,0	20,0	1/1		70,00
11723	55,5 x 35,0	20,0	1/1		70,00



## GN 2/4 „SUPERBOX“



Akazienholz / acacia wood / madera de acacia / bois d'acacia

	cm	↑ cm		Farbe / colour	€
11623	55,5 x 18,5	10,5			38,00
11629	55,5 x 18,5	10,5			38,00



## GN 1/2 „SUPERBOX“



Akazienholz / acacia wood / madera de acacia / bois d'acacia

	cm	↑ cm	GN	Farbe / colour	€
11621	35,0 x 29,0	10,5	1/2		30,00
11627	35,0 x 29,0	10,5	1/2		30,00
11722	35,0 x 29,0	20,0	1/2		45,00
11724	35,0 x 29,0	20,0	1/2		45,00



GN 1/4 „SUPERBOX“

Akazienholz / acacia wood / mader de acacia / bois d'acacia



	cm	↑ cm	Farbe / colour	€
11622	29 x 18,5	10,5		23,00
11628	29 x 18,5	10,5		23,00



Beschriftungsschilder, 2er Set

inscription labels, 2 pcs.  
étiquettes d'inscription, set de 2  
etiquetas de inscripción, set de 2



	cm	↑ cm	Farbe / colour	€ / set
11719	8 x 1,5	5,5		8,80



Kreide-Marker, 2er Set

chalk marker, 2 pcs.  
rotulador de tiza, set de 2  
marqueur a la craie liquide, set de 2



	Ø cm	↑ cm	pcs.	Farbe / colour	€ / set
71490	1	13	2		6,50



Buffetgestell

buffet stand  
soporte para buffet  
présentoir buffet

Metall, schwarz, passend für GN Boxen, mit Antirutschfüßchen

metal, black, suitable for GN boxes, with non-slip feet

metal, negro, para cajas GN, con pies antideslizantes

métal, noir, pour boîtes GN, avec pieds antidérapantsw



	cm	↑ cm	suitable for	Farbe / colour	€
30329	29 x 32,5	48	GN 1/2 boxes, height 10,5 cm		42,00
30331	49 x 38,5	48	GN 1/1, GN 1/2 boxes		50,00



Präsentationsmöglichkeit  
presentation example



**GN Tablett „ZERO“**

GN tray  
GN bandeja  
GN plateau



	cm	↑ cm	GN	€
84185	53,0 x 32,5	1,5	1/1	41,40
84186	32,5 x 26,5	1,5	1/2	22,40
84188	26,5 x 16,2	1,5	1/4	12,60
84189	53,0 x 16,2	1,5	2/4	24,60



**GN Naturschieferplatten „MORRA“**

GN natural slate tray  
GN bandeja de pizarra natural  
GN plat ardoise naturelle  
möbelschonende Unterseite, gebrochene Kanten  
non-scratching undersurface, broken edges  
base anti rayaduras, bordes biselados  
avec revêtement antirayures, bords biseautés



	cm	* mm	GN	€
00990	53,0 x 32,5	6 - 9	1/1	15,80
00991	32,5 x 26,5	6 - 9	1/2	8,80
00992	32,5 x 17,6	6 - 9	1/3	5,40
00993	26,5 x 16,2	6 - 9	1/4	5,00
00973	53,0 x 16,2	6 - 9	2/4	6,50



**GN Einsatz „SUPERBOX“**

GN insert  
GN bandeja  
GN bac supérieur



	cm	↑ cm	GN	fits to	€
11616	53,0 x 32,5	8,5	1/1	11620, 11626	32,00
11617	32,5 x 26,5	8,5	1/2	11621, 11627	26,40



**3 tlg.**  
3 pcs.

11645

11075

00979

10782

**Kühlakkus halten Ihre Speisen über lange Zeit kühl**  
coolers keep the food cool for a long time

**Kühlbox „SLATE“**  
refrigerated buffet display  
expositor buffet frío  
plateau buffet froid

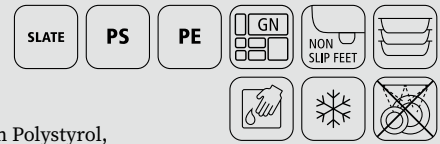

3-teilig, bestehend aus: 1 Basis aus schwarzem Polystyrol,  
1 Naturschieferplatte, 1 Kühlakku (ohne Haube)

3 pcs., set consists of: 1 base made of black polystyrene, 1 natural slate tray, 1 cooler (without cover)

set de 3 compuesto por: 1 soporte de poliestireno negro, 1 bandeja de pizarra natural, 1 acumulador de frío (sin campana)

set de 3 composé de: 1 support en polystyrène noir, 1 plateau en ardoise naturelle, 1 accumulateur de froid (sans couvercle)

	cm	↑ cm	€
11645	58 x 38	6,5	80,00

**Naturschieferplatte / natural slate tray / bandeja de pizarra natural / plateau ardoise naturelle**

	cm	✂ mm	€
00979	58 x 38	6 - 9	19,00

**Kühlakku / cooler / acumulador de frío / accumulateur de froid**

	cm	↑ cm	€
10782	41 x 21	2,5	16,00

**GN Rolltophaube mit schwarzem Griff / GN rolltop cover with black handle / GN campana rolltop con mango negro / GN cloche rolltop avec poignée noire**

	cm	↑ cm	GN	€
11075	53 x 32,5	19	1/1	62,00

**4 tlg.**  
4 pcs.

11100

11503

11505

11010

11505

10791

**Kühlakkus halten Ihre Speisen über lange Zeit kühl**  
coolers keep the food cool for a long time

**Kühlbox „TOP FRESH GN 1/1“**  
cooling plate  
bandeja de frío  
présentoir buffet réfrigéré



4-teilig: 1 Kühlbox + 1 Tablett GN 1/1 + 2 Kühlakkus, ohne Haube

4 pcs.: 1 box + 1 tray GN 1/1 + 2 coolers, without cover

set de 4: 1 caja + 1 bandeja GN 1/1 + 2 acumuladores de frío, sin campana

set de 4: 1 caisson + 1 plateau GN 1/1 + 2 accumulateurs de froid, sans cloche

	cm	↑ cm	Farbe / colour	€
11503	56,5 x 35	6,5	White	104,00
11505	56,5 x 35	6,5	Black	104,00

**GN Rolltophaube mit verchromtem Kreuzgriff / GN rolltop cover with chrome-plated cross handle / GN campana rolltop con asa en cruz cromada / GN cloche rolltop avec manche en croix chromée**

	cm	↑ cm	GN	€
11010	53 x 32,5	19	1/1 mit verchromtem Kreuzgriff	64,00

**Kühlakku / cooler / acumulador de frío / accumulateur de froid**

	cm	↑ cm	€
10791	25 x 19	2,5	8,40

**GN Edelstahl-Tablett „PROFI LINE“ / GN tray / GN bandeja / GN plateau**

	cm	↑ cm	GN	€
11100	53 x 32,5	1,5	1/1	31,00

## COOLING DISPLAYS

**4 tlg.**  
4 pcs.



11546



11075

**Buche, wasserfest lackiert**  
beech wood lacquered



10791

**Kühlakku halten Ihre Speisen  
über lange Zeit kühl**  
coolers keep the food  
cool for a long time

### Buffetvitrine „TOP FRESH GN 1/1“

refrigerated buffet display  
expositor buffet frío  
plateau buffet froid



4-teilig: 1 Box aus Buchenholz mit Kunststoffwanne + 1 Edelstahl-Tablett GN 1/1 +  
2 Kühlakku, ohne Haube

4 pcs.: 1 beech wood box with plastic insert + 1 stainless steel tray GN 1/1 + 2 coolers,  
without cover

set de 4: 1 caja de madera de haya con bandeja de plástico + 1 bandeja de acero inoxidable  
GN 1/1 + 2 acumuladores de frío, sin campana

set de 4: 1 boîte en bois de hêtre avec bac en plastique + 1 plateau en acier inox GN 1/1 + 2  
accumulateurs de froid, sans cloche

	cm	↑ cm	€
11546	60 x 41	5	200,00

**GN Rolltophaube mit schwarzem Griff / GN rolltop cover with black handle / GN campana**  
rolltop con mango negro / GN cloche rolltop avec poignée noir

	cm	↑ cm	GN	€
11075	53 x 32,5	19	1/1	62,00

**GN Rolltophaube mit Chromgriff / GN rolltop cover with chrome handle / GN campana**  
rolltop con asa cromada / GN cloche rolltop avec poignée chromée

	cm	↑ cm	GN	€
11010	53 x 32,5	19	1/1	64,00

**Kühlakku / cooler / acumulador de frío / accumulateur de froid**

	cm	↑ cm	€
10791	25 x 19	2,5	8,40

**12 tlg.**  
12 pcs.



11547



11075

**Buche, wasserfest lackiert**  
beech wood lacquered



10791

**Kühlakku halten Ihre Speisen  
über lange Zeit kühl**  
coolers keep the food  
cool for a long time

### Buffetvitrine „DOPPELDECKER GN 1/1“

refrigerated buffet display  
expositor buffet frío  
plateau buffet froid



12-teilig: 2 Boxen aus Buchenholz mit Kunststoffwanne + 2 Edelstahl-Tablets GN 1/1  
+ 4 Kühlakku + 4 verchromte Stangen, ohne Hauben

12 pcs.: 2 beech wood boxes with plastic insert + 2 stainless steel trays GN 1/1 + 4 coolers  
+ 4 chrome-plated bars, without covers

set de 12: 2 cajas de madera de haya con bandeja de plástico + 2 bandejas de acero inoxidable  
GN 1/1 + 4 acumuladores de frío + 4 barras cromadas, sin campanas

set de 12: 2 boîtes en bois de hêtre avec bac en plastique + 2 plateaux en acier inox GN 1/1  
+ 4 accumulateurs de froid + 4 barres chromées, sans cloches

	cm	↑ cm	€
11547	60 x 41	36	360,00

**GN Rolltophaube mit schwarzem Griff / GN rolltop cover with black handle / GN campana**  
rolltop con asa negra / GN cloche rolltop avec poignée noir

	cm	↑ cm	GN	€
11075	53 x 32,5	19	1/1	62,00

**GN Rolltophaube mit Chromgriff / GN rolltop cover with chrome handle / GN campana**  
rolltop con asa cromada / GN cloche rolltop avec poignée chromée

	cm	↑ cm	GN	€
11010	53 x 32,5	19	1/1	64,00

**Kühlakku / cooler / acumulador de frío / accumulateur de froid**

	cm	↑ cm	€
10791	25 x 19	2,5	8,40

**4 tlg.**  
4 pcs.



11540



11010

**Buche, wasserfest lackiert**  
beech wood lacquered



10791

**Kühlakku halten Ihre Speisen über lange Zeit kühl**  
coolers keep the food cool for a long time

**Buffetvitrine „TOP FRESH GN 1/1“**

refrigerated buffet display  
expositor buffet frío  
plateau buffet froid



4-teilig: 1 Box aus Buchenholz mit Kunststoffwanne + 1 Edelstahl-Tablett GN 1/1 + 2 Kühlakkus, ohne Haube

4 pcs.: 1 beech wood box with plastic insert + 1 stainless steel tray GN 1/1 + 2 coolers, without cover

set de 4: 1 caja de madera de haya con bandeja de plástico + 1 bandeja de acero inoxidable GN 1/1 + 2 acumuladores de frío, sin campana

set de 4: 1 boîte en bois de hêtre avec bac en plastique + 1 plateau en acier inox GN 1/1 + 2 accumulateurs de froid, sans cloche

	cm	↑ cm	€
11540	60 x 41	5	200,00

**GN Rolltophaube mit Chromgriff** / GN rolltop cover with chrome handle / GN campana rolltop con asa cromada / GN cloche rolltop avec poignée chromée

	cm	↑ cm	GN	€
11010	53 x 32,5	19	1/1	64,00

**Kühlakku** / cooler / acumulador de frío / accumulateur de froid

	cm	↑ cm	€
10791	25 x 19	2,5	8,40

**12 tlg.**  
12 pcs.



11541

**Buche, wasserfest lackiert**  
beech wood lacquered



10791

**Kühlakku halten Ihre Speisen über lange Zeit kühl**  
coolers keep the food cool for a long time

**Buffetvitrine „DOPPELDECKER GN 1/1“**

cooling buffet display  
expositor buffet frío  
vitrine buffet



12-teilig: 2 Boxen aus Buchenholz mit Kunststoffwanne + 2 Edelstahl-Tabletts GN 1/1 + 4 Kühlakkus + 4 verchromte Stangen, ohne Hauben

12 pcs.: 2 beech wood boxes with plastic insert + 2 stainless steel trays GN 1/1 + 4 coolers + 4 chrome-plated bars, without covers

set de 12: 2 cajas de madera de haya con bandeja de plástico + 2 bandejas de acero inoxidable GN 1/1 + 4 acumuladores de frío + 4 barras cromadas, sin campanas

set de 12: 2 boîtes en bois de hêtre avec bac en plastique + 2 plateaux en acier inox GN 1/1 + 4 accumulateurs de froid + 4 barres chromées, sans cloches

	cm	↑ cm	€
11541	60 x 41	36	360,00

**GN Rolltophaube mit Chromgriff** / GN rolltop cover with chrome handle / GN campana rolltop con asa cromada / GN cloche rolltop avec poignée chromée

	cm	↑ cm	GN	€
11010	53 x 32,5	19	1/1 Chrom-Griff	64,00

**Kühlakku** / cooler / acumulador de frío / accumulateur de froid

	cm	↑ cm	€
10791	25 x 19	2,5	8,40

## COOLING DISPLAYS



09100



90902



11101

**Kühlakkus halten Ihre Speisen  
über lange Zeit kühl**  
coolers keep the food  
cool for a long time

### Buffetvitrine

showcase  
vitrina de buffet  
vitrine de buffet



5-teilig: 1 transparente Rolltophaube beidseitig aufklappbar + 1 Schale  
+ 1 Edelstahl-Tablett 39 x 28 cm + 2 Kühlakkus

5 pcs.: 1 transparent rolltop cover + 1 tray + 1 stainless tray 39 x 28 cm + 2 coolers

set de 5: 1 tapa abatible, por ambos lados, transparente + 1 bandeja + 1 bandeja de acero inoxidable 39 x 28 cm + 2 acumuladores de frío

set de 5: 1 cloche transparente ouverture 2 côtés + 1 caisson + 1 plateau en acier inox 39 x 28 cm + 2 accumulateurs de froid

	cm	↑ cm	Farbe / colour	€
09100	44 x 32	20,5	White	53,00
09104	44 x 32	20,5	Black	53,00

### Kühlakku / cooler / acumulador de frío / accumulateur de froid

	cm	↑ cm	pcs.	€ / set
11101	16 x 7,5	2	4	7,40

### Edelstahl-Tablett / stainless steel tray / bandeja de acero inoxidable / plateau inox

	cm	↑ cm	€
90902	39,5 x 28,5	1	10,40



09200



09204



11101

**Kühlakkus halten Ihre Speisen  
über lange Zeit kühl**  
coolers keep the food  
cool for a long time

### Buffetvitrine „DOPPELDECKER“

showcase  
vitrina de buffet, 2 alturas  
vitrine de buffet double



2 transparente Rolltophauben beidseitig aufklappbar + 2 Schalen + 2 Edelstahl-Tabletts 39 x 28 cm + 4 Kühlakkus, platzsparend lagerbar

2 transparent rolltop cover + 2 trays + 2 tray 39 x 28 cm + 4 coolers, space saving

2 campanas abatibles por ambos lados transparentes + 2 bandejas + 2 bandejas de acero inoxidable 39 x 28 cm + 4 acumuladores de frío, almacenamiento en poco espacio

2 cloches transparentes abattantes 2 côtés + 2 caissons + 2 plateaux en acier inox 39 x 28 cm + 4 accumulateurs de froid, peut encombrant à stocker

	cm	↑ cm	Farbe / colour	€
09200	44 x 32	44	White	104,00
09204	44 x 32	44	Black	104,00

### Kühlakku / cooler / acumulador de frío / accumulateur de froid

	cm	↑ cm	pcs.	€ / set
11101	16 x 7,5	2	4	7,40

### Edelstahl-Tablett / stainless steel tray / bandeja de acero inoxidable / plateau inox

	cm	↑ cm	€
90902	39,5 x 28,5	1	9,60

**6 tlg.**  
**6 pcs.**



09091



09090



11101

**Kühlakkus halten Ihre Speisen  
über lange Zeit kühl**  
coolers keep the food  
cool for a long time

**Thermo Tablett-Set, 6-teilig**

thermo tray, 6 pcs.

bandeja térmica, set de 6  
plateau thermique, set de 6



- 6-teilig:
- 1 Schale
  - 1 Edelmetalltablett
  - 2 Kühlakkus
  - 1 transparente Frischhaltehaube
  - 1 Transport- und Tragegurt aus Silikon

- 6 pcs.:
- 1 plastic tray
  - 1 stainless steel tray
  - 2 coolers
  - 1 transparent cover
  - 1 silicone transport and carrying strap

- set de 6:
- 1 bandeja de plástico
  - 1 bandeja de acero inoxidable
  - 2 acumuladores de frío
  - 1 campana transparente
  - 1 correa de silicona para cierre y transporte

- set de 6:
- 1 plateau plastique
  - 1 plateau en acier inox
  - 2 accumulateurs de froid
  - 1 cloche transparente
  - 1 sangle en silicone pour fermeture et transport

	cm	↑ cm	Farbe / colour	€
09091	43 x 29	14		27,00
09090	43 x 29	14		27,00



inklusive 2 Kühlakkus  
including 2 coolers



**6 tlg.**  
**6 pcs.**



09094



09093

11101

**Kühlakkus halten Ihre Speisen  
über lange Zeit kühl**  
coolers keep the food  
cool for a long time

**Thermo Tablett-Set, 6-teilig**

thermo tray, 6 pcs.

bandeja térmica, set de 6  
plateau thermique, set de 6



- 6-teilig:
- 1 Schale
  - 1 Edelmetalltablett
  - 2 Kühlakkus
  - 1 transparente Frischhaltehaube
  - 1 Transport- und Tragegurt aus Silikon

- 6 pcs.:
- 1 plastic tray
  - 1 stainless steel tray
  - 2 coolers
  - 1 transparent cover
  - 1 silicone transport and carrying strap

- set de 6:
- 1 bandeja de plástico
  - 1 bandeja de acero inoxidable
  - 2 acumuladores de frío
  - 1 campana transparente
  - 1 correa de silicona para cierre y transporte

- set de 6:
- 1 plateau plastique
  - 1 plateau en acier inox
  - 2 accumulateurs de froid
  - 1 cloche transparente
  - 1 sangle en silicone pour fermeture et transport

	cm	↑ cm	Farbe / colour	€
09094	35	15		27,00
09093	35	15		27,00



inklusive 2 Kühlakkus  
including 2 coolers

## COOLING DISPLAYS



### Kühltablett „TOP FRESH RUND“

refrigerated buffet display  
expositor buffet frío redondo  
présentoir buffet



3-teilig: 1 Box aus Buchenholz mit Kunststoffwanne + 1 Edelstahl-Tablett Ø 38 cm  
+ 1 Kühlakku, ohne Haube

3 pcs.: 1 beech wood box with plastic insert + 1 stainless tray Ø 38 cm + 1 cooler, without cover

set de 3: 1 caja de madera de haya con bandeja de plástico + 1 bandeja de acero inoxidable Ø 38 cm + 1 acumulador de frío, sin campana

set de 3: 1 boîte en bois de hêtre avec bac en plastique + 1 plateau en acier inox Ø 38 cm + 1 accumulateur de froid, sans cloche

	Ø cm	↑ cm	€
11542	48	6	200,00

Rolltophaube mit verchromtem Kugelgriff / rolltop cover with chrome-plated ball handle / campana abatible con asa de bola cromada / cloche basculante avec poignée boule chromée

	Ø cm	↑ cm	€
18388	38	20	24,00

Rolltophaube mit vergoldetem Kugelgriff / rolltop cover with gold-plated ball handle / campana abatible con asa de bola dorada / cloche basculante avec poignée boule plaquée or

	Ø cm	↑ cm	€
18387	38	20	24,00

Kühlakku / cooler / acumulador de frío / accumulateur de froid

	cm	↑ cm	€
10791	25 x 19	2,5	8,40



### Thermo-Set

thermo set  
bandeja isotérmica  
set thermo



5-teilig: 1 Tablett tief + 1 Tablett flach + 2 Kühlakkus + 1 Rolltophaube

5 pcs.: 1 deep tray + 1 tray + 2 cooler + 1 rolltop cover

set de 5: 1 1 bandeja honda + 1 bandeja plana + 2 acumuladores frío + 1 campana rolltop

set de 5: 1 plateau creux + 1 plateau plat + 2 accumulateurs de froid + 1 cloche rolltop

	Ø cm	↑ cm	€
09082	38	24	56,00

Rolltophaube mit verchromtem Kugelgriff / rolltop cover with chrome-plated ball handle / campana abatible con asa de bola cromada / cloche basculante avec poignée boule chromée

	Ø cm	↑ cm	€
18388	38	20	24,00

Kühlakku / cooler / acumulador de frío / accumulateur de froid

	cm	↑ cm	pcs.	€ / set
11101	16 x 7,5	2	4	7,40



### Schale „CASUAL MAXI“

bowl  
cuenco  
bol



	Ø cm	↑ cm	ltr.	Farbe / colour	€
83702	23	10,5	2,50	White	11,80
83703	23	10,5	2,50	Black	11,80

4 tlg.  
4 pcs.



11845 2,5 ltr.



11875



10777

**Kühlakkus halten  
Ihre Speisen  
über lange Zeit kühl**  
coolers keep the food  
cool for a long time

**Kühlschale Maxi „TOP FRESH“**

cool bowl maxi  
cuenco refrigerado maxi  
bol réfrigéré maxi



4-teilig: 1 Gefäß hochglanzpoliert + 1 Kühlakku + 1 Glasschale + 1 klappbarer Deckel mit Beschriftungsschild

4 pcs.: 1 stainless steel bowl mirror polished + 1 cooler + 1 glass bowl + 1 hinged cover with label

set de 4: 1 recipiente de acero inoxidable pulido brillante + 1 acumulador de frío + 1 cuenco de vidrio + 1 tapa abatible con etiqueta

set de 4: 1 récipient en acier inox poli brillant + 1 accumulateur de froid + 1 bol en verre + 1 couvercle à charnière avec étiquette

	Ø cm	↑ cm	ltr.	€
11845	23	14	2,5	84,00

**Ersatzschale / spare bowl / cuenco de recambio / bol de rechange**

	Ø cm	↑ cm	ltr.	VE / unit	€ / pc.
11875	23,0	10,5	2,50	6	7,60

**Schutzdeckel mit Löffelaussparung / cover / tapa / couvercle**

	Ø cm	€
11878	23,5	12,60

**Kühlakku / cooler / acumulador de frío / accumulateur de froid**

	Ø cm	↑ cm	€
10777	15	2,5	5,40



11859



11866



11865



11875

**Schale**

bowl  
cuenco  
bol



	Ø cm	↑ cm	ltr.	VE / unit	€ / pc.
11859	6,0	2,5	0,05	6	2,00
11866	7,5	3,5	0,09	6	2,00
11865	14,0	6,5	0,50	6	3,30
11875	23,0	10,5	2,50	6	7,60

## COOLING DISPLAYS



4 tlg.  
4 pcs.

11812 0,6 ltr.

11813 1,0 ltr.

### Kühlschale Mini Holz „TOP FRESH“

cool bowl mini holz  
bol refrigerado mini madera  
bol réfrigéré mini bois

BEECH  
WOOD

PLASTIC

ABS



4-teilig: 1 Fuß Buchenholz versiegelt + 1 Schale + 1 Kühlakku + 1 klappbarer Deckel mit Beschriftungsschild

4 pcs.: 1 foot beech wood + 1 bowl + 1 cooler + 1 hinged cover with label

set de 4: 1 base de madera de haya + 1 cuenco + 1 acumulador de frío + 1 tapa abatible con etiqueta

set de 4: 1 pied en hêtre + 1 bac + 1 accumulateur de froid + 1 couvercle à charnière avec étiquette

	Ø cm	↑ cm	ltr.	€
11812	14	9,0	0,6	44,00
11813	14	11,5	1,0	48,00

Ersatzschale / spare bowl / cuenco de recambio / bol de rechange

	Ø cm	↑ cm	€
11811	14	6,5	18,20
11816	14	9,0	25,40

Schutzdeckel mit Löffelaussparung / cover / tapa / couvercle

	Ø cm	€
11868	14,5	12,00

Kühlakku / cooler / acumulador de frío / accumulateur de froid

	Ø cm	↑ cm	€
10661	10,5	2	3,40



4 tlg.  
4 pcs.

11817 2,5 ltr.

11818 4,0 ltr.

### Kühlschale Maxi Holz „TOP FRESH“

cool bowl maxi holz  
bol refrigerado maxi madera  
bol réfrigéré maxi bois

BEECH  
WOOD

PLASTIC

ABS



4-teilig: 1 Fuß Buchenholz versiegelt + 1 Schale + 1 Kühlakku + 1 klappbarer Deckel mit Beschriftungsschild

4 pcs.: 1 foot beech wood + 1 bowl + 1 cooler + 1 hinged cover with label

set de 4: 1 base de madera de haya + 1 cuenco + 1 acumulador de frío + 1 tapa abatible con etiqueta

set de 4: 1 pied en hêtre + 1 bac + 1 accumulateur de froid + 1 couvercle à charnière avec étiquette

	Ø cm	↑ cm	ltr.	€
11817	22	14	2,5	104,00
11818	22	18	4,0	112,00

Ersatzschale / spare bowl / cuenco de recambio / bol de rechange

	Ø cm	↑ cm	€
11846	22	8	41,00
11848	22	12	54,00

Schutzdeckel mit Löffelaussparung / cover / tapa / couvercle

	Ø cm	€
11878	23,5	12,60

Kühlakku / cooler / acumulador de frío / accumulateur de froid

	Ø cm	↑ cm	€
10777	15	2,5	5,40

4 tlg.  
4 pcs.



11810 0,6 ltr.



11815 1,0 ltr.

**Kühlschale Mini „TOP FRESH“**

cool bowl mini  
bol refrigerado mini  
bol réfrigéré mini



4-teilig: 1 Edelstahlgefäß matt + 1 Kühlakku + 1 Schale + 1 klappbarer Deckel mit Beschriftungsschild

4 pcs.: 1 stainless steel bowl matt + 1 bowl + 1 cooler + 1 hinged cover with label  
set de 4: 1 recipiente de acero inoxidable mate + 1 cuenco + 1 acumulador de frío + 1 tapa abatible con etiqueta

set de 4: 1 récipient en acier inox mat + 1 bac + 1 accumulateur de froid + 1 couvercle à charnière avec étiquette

	Ø cm	↑ cm	ltr.	€
11810	14	9,0	0,6	48,00
11815	14	11,5	1,0	50,00

**Ersatzschale / spare bowl / cuenco de recambio / bol de rechange**

	Ø cm	↑ cm	€
11811	14	6,5	18,20
11816	14	9,0	25,40

**Schutzdeckel mit Löffelaussparung / cover / tapa / couvercle**

	Ø cm	€
11868	14,5	12,00

**Kühlakku / cooler / acumulador de frío / accumulateur de froid**

	Ø cm	↑ cm	€
10661	10,5	2	3,40

4 tlg.  
4 pcs.



11847 2,5 ltr.



11849 4,0 ltr.

**Kühlschale Maxi „TOP FRESH“**

cool bowl maxi  
bol refrigerado maxi  
bol réfrigéré maxi



4-teilig: 1 Edelstahlgefäß hochglanzpoliert + 1 Kühlakku + 1 Schale + 1 klappbarer Deckel mit Beschriftungsschild

4 pcs.: 1 stainless steel bowl mirror polished + 1 bowl + 1 cooler + 1 hinged cover with label  
set de 4: 1 recipiente de acero inoxidable pulido brillante + 1 cuenco + 1 acumulador de frío + 1 tapa abatible con etiqueta

set de 4: 1 récipient en acier inox poli brillant + 1 bac + 1 accumulateur de froid + 1 couvercle à charnière avec étiquette

	Ø cm	↑ cm	ltr.	€
11847	22	14	2,5	108,00
11849	22	18	4,0	112,00

**Ersatzschale / spare bowl / cuenco de recambio / bol de rechange**

	Ø cm	↑ cm	€
11846	22	8	41,00
11848	22	12	54,00

**Schutzdeckel mit Löffelaussparung / cover / tapa / couvercle**

	Ø cm	€
11878	23,5	12,60

**Kühlakku / cooler / acumulador de frío / accumulateur de froid**

	Ø cm	↑ cm	€
10777	15	2,5	5,40

# BUFFET GUARD

**3 Höhen einstellbar**  
3 heights adjustable

Servierbeispiel  
presentation example



**schwenkbar**  
swivelling



## Hygieneschutz „BUFFET GUARD“

sneeze guard  
protector anti aliento  
pare-haleine



- transparente, höhenverstellbare Acrylplatte 80 x 53 cm
- Neigungswinkel stufenlos einstellbar
- transparent, height-adjustable acrylic plate 80 x 53 cm
- tilt angle continuously adjustable
- placa acrílica transparente y de altura ajustable 80 x 53 cm
- el ángulo de inclinación es infinitamente variable
- plaque en acrylique transparente 80 x 53 cm et réglable en hauteur
- angle d'inclinaison variable à l'infini

	cm	↑ cm	✂ mm	Fuß / base	€
98120	93 x 53	50,5	5	Metall schwarz / metal black	159,00



**Antirutschfüßchen**  
non-slip feet



**Der Neigungswinkel der Acrylplatte ist flexibel einstellbar**  
the angle of inclination of the acrylic plate is flexibly adjustable



**Höheneinstellung der Acrylplatte in 3 Höhen (20 cm - 30 cm - 40 cm)**  
height adjustment of the acrylic plate in 3 steps. (20 cm - 30 cm - 40 cm)



**Anwendungsbeispiel**  
application example



**Lieferung erfolgt demontiert**  
delivery takes place disassembled



**Hygieneschutz**  
hygienic cover  
campana higiénica antialiento  
pare-haleine



- transparente Acrylabdeckung 75 x 42,5 cm
- Gestell aus Metall, verchromt
- transparent acrylic cover 75 x 42.5 cm
- frame made of metal, chrome-plated
- cubierta de acrílico transparente 75 x 42,5 cm
- marco de metal cromado
- couvercle acrylique transparent 75 x 42,5 cm
- structure en métal chromé

	cm	↑ cm	€
11556	82 x 42	45	220,00



**Brötchenspender**  
roll dispenser  
dispensador de panecillos  
distributeur de petits pains



hygienisch und einfach zu reinigen, mit Krümelschale  
hygienic and easy to clean, with crumb tray  
higiénico y fácil de limpiar, con bandeja para migas  
hygiénique et facile à laver, avec plat ramasse-miettes

	cm	↑ cm		€
11572	33 x 27	42	für ca. 45-50 Brötchen / for approx. 45-50 rolls para 45-50 panecillos / pour 45-50 petits pains	199,00
11573	33 x 27	56	für ca. 65-70 Brötchen / for approx. 65-70 rolls para 65-70 panecillos / pour 65-70 petits pains	229,00



Krümelschale  
crumb tray



**Haubenthalter „FLEXIBLE“**  
cover holder  
soporte de la campana  
support de la cloche



Bei dieser Haubenthalter wird die Haube am Griff in die Vorrichtung gesteckt.  
Für APS-Hauben geeignet!

With this cover holder, the cover is inserted into the device by the handle.  
Suitable for APS covers!

Con este soporte de campana, la campana se cuelga simplemente por el asa.  
¡Para campanas de APS!

Avec ce support, la cloche s'accroche simplement par la poignée.  
Pour cloches APS!

	cm	↑ cm	€
33288	35,5 x 30	39	120,00



Präsentationsmöglichkeit  
presentation example

# DRAWER SET



00910  
3-teiliges Set  
3 pcs. set

50807  
2 x Korb, schwarz



3 tlg.  
3 pcs.



00910



00911  
mit Antirutsch Füßchen  
with non-slip feet



00912

## Schubladen Set, 3-teilig

drawer set, 3 pcs.  
cajonera, set de 3  
set tiroir, set de 3

3-teiliges Set:

- 1 Ständer aus Metall schwarz
- 1 Schublade mit Griff schwarz
- 1 Schneidebrett aus geöltem Walnussholz

3 pcs. set:

- 1 stand made of metal black
- 1 drawer with handle black
- 1 oiled walnut wood cutting board

set de 3:

- 1 soporte de metal negro
- 1 cajón con asa negra
- 1 tabla de cortar de madera de nogal engrasada

set de 3:

- 1 support métallique noir
- 1 tiroir avec poignée noire
- 1 planche à découper en bois de noyer huilé



	cm	↑ cm	€
00910	35,4 x 32,5	20	192,00



15506

00912



00911

Präsentationsmöglichkeit  
presentation example

Einzelteile / parts / piezas / pièces

	cm	↑ cm		€
00911	35,4 x 32,5	3,5	Schneidebrett / cutting board	84,00
00912	34,0 x 32,0	17,5	Schublade, Griff schwarz / drawer, handle black	82,00
15506	35,4 x 32,5	17,6	GN Buffetständer schwarz/ GN buffet stand black	25,00

# SNACKPRESENTER

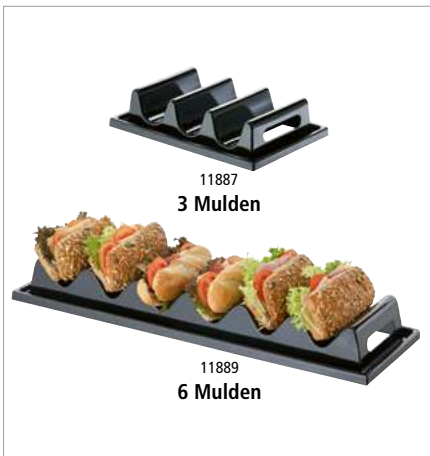

## Snackpresenter

snackpresenter  
dispensador de bocadillos  
présentoir à sandwiches  
mit Safrille und Griffmulde, passend für Vitrine 11888



with recessed grip, suitable for showcase 11888  
asa moldeada, apto para la vitrina 11888  
anse moulée, apte pour vitrine 11888

	cm	↑ cm		€
11887	29 x 19	6,5	3 Mulden / 3 compartments 3 compartimentos / 3 compartments	22,00
11889	60 x 19	7,5	6 Mulden / 6 compartments 6 compartimentos / 6 compartments	25,00



## Snackpresenter

snackpresenter  
dispensador de bocadillos  
présentoir à sandwiches  
hochglanzpoliert, mit Griffmulde, für 7 Baguettes



mirror polished, with recessed grip, for 7 baguettes  
pulido brillante, con asa empotrada, ideal para 7 bocadillos  
poli brillant, avec poignée encastrée, parfait pour 7 sandwiches

	cm	↑ cm		€
11891	47,5 x 10,5	6		32,00



## Snackpresenter

snackpresenter  
dispensador de bocadillos  
présentoir à sandwiches



	cm	↑ cm		€
11969	56 x 8	5,5		14,00



## Vitrine / Thekenaufsatz

showcase  
vitrina de mostrador  
vitrine de comptoir  
rutschfest, aus einem Teil gefertigt



non-slip, monoblock produced  
antideslizante, fabricado en 1 pieza  
antidérapante, fabriquée en une seule pièce

	cm	↑ cm		€
11888	63,5 x 25	25		89,00

# FROSTFIRE

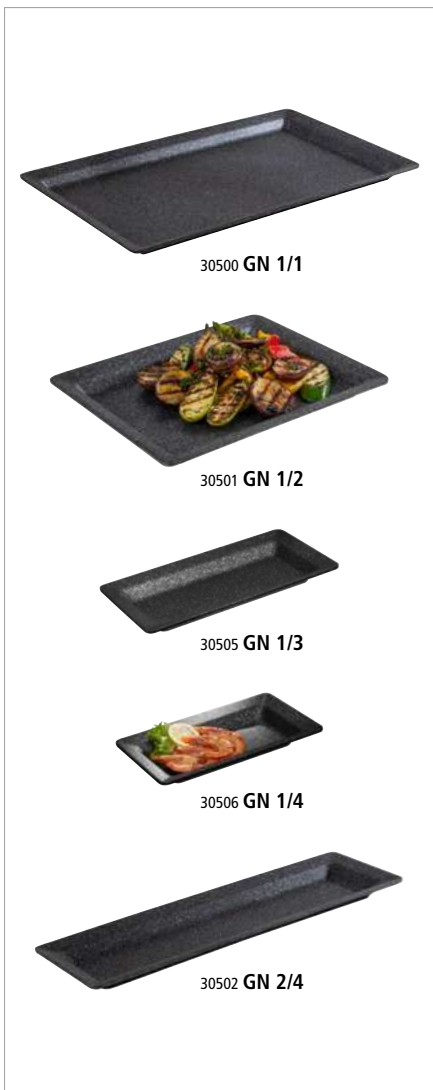

## GN Tablett „FROSTFIRE“

GN tray  
GN bandeja  
GN plateau



Antihftbeschichtung / non stick coating / antiadherente / revêtement anti-adhésif

	cm	↑ cm	GN	Farbe / colour	€
30500	53,0 x 32,5	3	1/1	black / silver	57,00
30501	32,5 x 26,5	3	1/2	black / silver	40,00
30505	32,5 x 17,6	3	1/3	black / silver	30,00
30506	26,5 x 16,2	3	1/4	black / silver	26,00
30502	53,0 x 16,2	3	2/4	black / silver	42,00

GN 1/1	GN 1/2	GN 1/3	GN 2/4	GN 1/4
	GN 1/2	GN 1/3		GN 1/4

2 Höhen – 4,5 und 7,5 cm  
2 heights – 4,5 and 7,5 cm



30514  
GN 1/1 – 4,5 cm



30507  
GN 1/2 – 7,5 cm



30511  
GN 1/4 – 4,5 cm



30516  
GN 1/6 – 7,5 cm



30513  
GN 2/4 – 4,5 cm

GN Schale „FROSTFIRE“

GN bowl  
GN cuenco  
GN bol

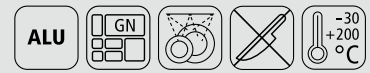

Antihafbeschichtung / non stick coating / antiadherente / revêtement anti-adhésif

	cm	↑ cm	ltr.	GN	Farbe / colour	€
30514 <b>NEW</b>	53,0 x 32,5	4,5	4,5	1/1	black / silver	74,00
30512 <b>NEW</b>	32,5 x 26,5	4,5	2,4	1/2	black / silver	44,00
30511 <b>NEW</b>	26,5 x 16,2	4,5	1,0	1/4	black / silver	30,00
30513 <b>NEW</b>	53,0 x 16,2	4,5	2,1	2/4	black / silver	45,00

	cm	↑ cm	ltr.	GN	Farbe / colour	€
30515 <b>NEW</b>	53,0 x 32,5	7,5	9,0	1/1	black / silver	82,00
30507	32,5 x 26,5	7,5	4,5	1/2	black / silver	48,00
30508	26,5 x 16,2	7,5	2,0	1/4	black / silver	37,00
30516 <b>NEW</b>	17,6 x 16,2	7,5	1,3	1/6	black / silver	32,00
30509	53,0 x 16,2	7,5	4,25	2/4	black / silver	52,00



Schale „FROSTFIRE“

bowl  
cuenco  
bol



Antihafbeschichtung / non stick coating / antiadherente / revêtement anti-adhésif

	Ø cm	↑ cm	ltr.	Farbe / colour	€
30510	45	10	5,6	black / silver	84,00





30517



30503



30504



30518

**Schale „FROSTFIRE“**

bowl  
cuenco  
bol



Antihafbeschichtung / non stick coating / antiadherente / revêtement anti-adhésif

	cm	↑ cm	ltr.	Farbe / colour	€
30517 <small>NEW</small>	12,5 x 12,5	6,5	0,5	black / silver	22,00
30503	19,0 x 19,0	9,0	1,5	black / silver	29,00
30504	25,0 x 25,0	12,0	3,8	black / silver	45,00
30518 <small>NEW</small>	30,0 x 30,0	14,0	8,0	black / silver	66,00



**Dressingtopf / Flaschenkühler „FROSTFIRE“**

dressing pot / bottle cooler  
salsera / enfriador de botella  
pot à sauce / rafraîchisseur



Antihafbeschichtung / non stick coating / antiadherente / revêtement anti-adhésif

	Ø cm	↑ cm	ltr.	Farbe / colour	€
36140	11,5 / 11	15	1,4	black / silver	18,60



auch als Flaschenkühler verwendbar  
also usable as a bottle cooler



Schale „FROSTFIRE“

bowl  
cuenco  
bol



Antihafbeschichtung / non stick coating / antiadherente / revêtement anti-adhésif

	Ø cm	↑ cm	ltr.	Farbe / colour	€
30017	26,5	7 / 12	1,9	beige / sand	42,00
30019	26,5	7 / 12	1,9	red	42,00
30018	26,5	7 / 12	1,9	green	42,00
30015	26,5	7 / 12	1,9	black / silver	42,00
30016	26,5	7 / 12	1,9	black	42,00



★★★★★  
for cold  
& hot dishes



**Schale „FROSTFIRE“**

bowl  
cuenco  
bol

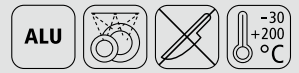

Antihftbeschichtung / non stick coating / antiadherente / revêtement anti-adhésif

	∅ cm	↑ cm	ltr.	Farbe / colour	€
30024	32,5	8 / 14	3	beige / sand	48,00
30014	32,5	8 / 14	3	red	48,00
30013	32,5	8 / 14	3	green	48,00
30010	32,5	8 / 14	3	black / silver	48,00
30011	32,5	8 / 14	3	black	48,00

30024

30014

30013

30010

30011



**Wärmelampe mit 2 Infrarotlampen**

thermal bridge  
puente térmico  
pont thermique



**höhenverstellbar 58 - 77,5 cm, inklusive 2 Lampen, Kabellänge: 1,5 Meter**

height ajustable from 58 to 77,5 cm, including 2 infrared lamps, cable length: 1,5 metres  
regulable en altura de 58 a 77,5 cm, con 2 lámparas de infrarrojas, longitud del cable: 1,5 metros  
réglable en hauteur de 58 à 77,5 cm, avec 2 lampes infrarouges, longueur du câble: 1,5 mètre

	cm	↑ cm	V	W	€
12265	50 x 35	58 - 77,5	230	2 x 250	145,00

**Ersatzbirne für Wärmelampe**

infrared lamp / bulb  
lámpara infrarroja / bombilla  
lampe infrarouge / ampoule

**Fassung E27, Lichtfarbe: warmweiß**

socket: E27, light colour: warm white  
casquillo: E27, color de la luz: blanco cálido  
douille: E27, couleur de lumière: blanc chaud

	W	fits to	€
12266	250	12265, 12267	11,00



**Wärmelampe mit Infrarotlampe**

thermal bridge  
puente térmico  
pont thermique



**mit flexibel einstellbarem Arm, stabiler Standfuß, Kabellänge: 1,5 Meter**

with flexibly adjustable arm, stable base, cable length: 1,5 metres  
con brazo ajustable de forma flexible, base estable, longitud del cable: 1,5 metros  
avec bras réglable de manière flexible, socle stable, longueur de câble : 1,5 mètre

	cm	↑ cm	V	W	€
12267	27 x 20,5	68	230	1 x 250	145,00

**Ersatzbirne für Wärmelampe**

infrared lamp / bulb  
lámpara infrarroja / bombilla  
lampe infrarouge / ampoule

**Fassung E27, Lichtfarbe: warmweiß**

socket: E27, light colour: warm white  
casquillo: E27, color de la luz: blanco cálido  
douille: E27, couleur de lumière: blanc chaud

	W	fits to	€
12266	250	12265, 12267	11,00



# TERRAZZO



NEW



30080



30081



30082

## Schale „TERRAZZO“

bowl  
cuenco  
bol

Terrazzooptik  
terrazzo look  
aspecto terrazo  
optique terrazzo



	Ø cm	↑ cm	ltr.	€
30080	22,0	6,0 / 10,5	1,1	24,00
30081	26,0	7,5 / 13,0	1,7	31,00
30082	29,5	8,5 / 14,5	2,5	36,00

Farb- und Strukturabweichungen möglich  
colour and texture variations possible

# SPHERE



## Schale, 3er Set „SPHERE“

bowl, 3 pcs.  
cuenco, set de 3  
bol, set of 3



innen: mattiert / inside: matt / interior: mate / intérieur: mat

	Ø cm	↑ cm	ltr.	Farbe / colour	pcs.	€ / set
40770	8	7	0,1	gold	3	28,00
40771	8	7	0,1	copper	3	28,00
40772	8	7	0,1	gunmetal	3	28,00



## Schale „SPHERE“

bowl  
cuenco  
bol



innen: mattiert / inside: matt / interior: mate / intérieur: mat

	Ø cm	↑ cm	ltr.	Farbe / colour	€
40773	16	15	0,8	gold	22,00
40774	16	15	0,8	gunmetal	22,00



## Schale „SPHERE“

bowl  
cuenco  
bol



innen: mattiert / inside: matt / interior: mate / intérieur: mat

	Ø cm	↑ cm	ltr.	Farbe / colour	€
40775	24	21	2	gold	33,00
40776	24	21	2	gunmetal	33,00

# PERFECTO



## Buffetständer „PERFECTO“

buffet stand  
soporte para buffet  
présentoir buffet



Gestell aus Metall mit schwarzer Antirutschbeschichtung  
metal frame with black anti-slide coating  
soporte de metal con revestimiento antideslizante negro  
structure en métal avec revêtement antidérapant noir

	cm	↑ cm	fits to	€
33304	23 x 19	40,5	33302, 33303	25,00
33308 <small>NEW</small>	23 x 19	59,5	33302, 33303	28,00



## Buffetbrett „PERFECTO“

buffet board  
tabla de buffet  
planche de buffet



	cm	↑ cm	fits to	€
33302	20 x 20	2	33304, 33308	16,40
33303	80 x 20	2	33304, 33308	62,00

3 tlg.  
3 pcs.



2-stufige Etagère „PERFECTO SMALL“

2-tier tray  
bandeja dos alturas  
étagère carré 2 hauteurs



3-teiliges Set, bestehend aus:

- 1 Buffetständer aus Metall mit schwarzer Antirutschbeschichtung, 23 x 19 cm, H: 40,5 cm
- 2 Bretter aus Eichenholz, geölt, 20 x 20 cm, H: 2 cm

3 pcs., consisting of:

- 1 buffet stand metal with black anti-slide coating, 23 x 19 cm, h: 40,5 cm
- 2 boards, oiled oak, 20 x 20 cm, h: 2 cm

set de 3, compuesto por:

- 1 soporte para buffet metal con revestimiento antideslizante negro, 23 x 19 cm, a: 40,5 cm
- 2 tablas de roble, aceitadas, 20 x 20 cm, a: 2 cm

set de 3, composé de :

- 1 présentoir buffet métal avec revêtement antidérapant noir, 23 x 19 cm, h: 40,5 cm
- 2 planches en bois de chêne, huilées, 20 x 20 cm, h: 2 cm

	cm	↑ cm	€
33300	23 x 20	40,5	56,80

4 tlg.  
4 pcs.



2-stufige Etagère „PERFECTO LARGE“

2-tier tray  
bandeja dos alturas  
étagère carré 2 hauteurs



4-teiliges Set, bestehend aus:

- 2 Buffetständer aus Metall mit schwarzer Antirutschbeschichtung, 23 x 19 cm, H: 40,5 cm
- 2 Bretter aus Eichenholz, geölt, 80 x 20 cm, H: 2 cm

4 pcs., consisting of:

- 2 buffet stand metal with black anti-slide coating, 23 x 19 cm, h: 40,5 cm
- 2 boards, oiled oak, 80 x 20 cm, h: 2 cm

set de 4, compuesto por:

- 2 soporte para buffet metal con revestimiento antideslizante negro, 23 x 19 cm, a: 40,5 cm
- 2 tablas de roble, aceitadas, 80 x 20 cm, a: 2 cm

set de 4, composé de :

- 2 présentoir buffet métal avec revêtement antidérapant noir, 23 x 19 cm, h: 40,5 cm
- 2 planches en bois de chêne, huilées, 80 x 20 cm, h: 2 cm

	cm	↑ cm	€
33301	80 x 23	40,5	170,00



33304 33303 33304 33303 33304



33308 33302 33302 33302



# SERVING STANDS

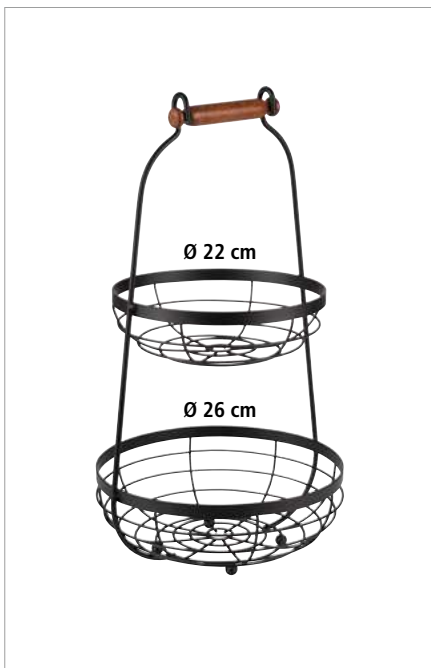

## 2-stufige Etagère

2-tier étagère  
cesta doble 2 alturas  
étagère 2 paniers

oberer Korb (Ø 22 cm, H: 6 cm), unterer Korb (Ø 26 cm, H: 8 cm)  
upper basket (Ø 22 cm, H: 6 cm), lower basket (Ø 26 cm, H: 8 cm)  
cesta superior (Ø 22 cm, H: 6 cm), cesta inferior (Ø 26 cm, H: 8 cm)  
corbeille supérieure (Ø 22 cm, H: 6 cm), corbeille inférieure (Ø 26 cm, H: 8 cm)

METAL ACACIA WOOD

	Ø cm	↑ cm	€
30335	26	48	40,00



Präsentationsmöglichkeiten  
presentation examples

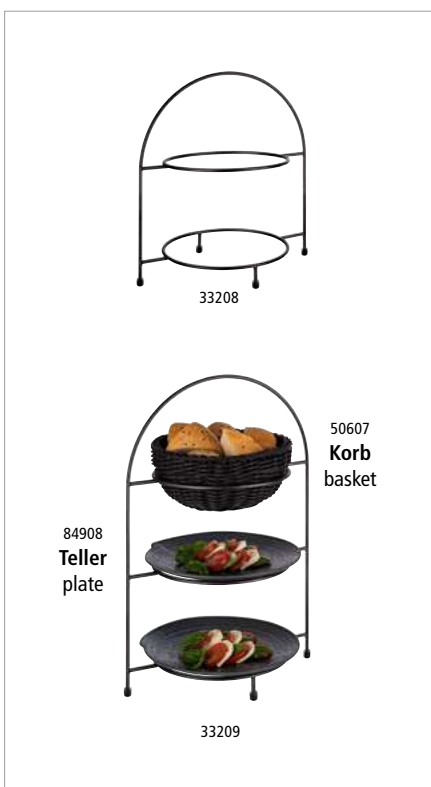

## Serviergestell „INDUSTRIAL“

serving stand  
soporte platos  
présentoir à assiettes

für Teller max. Ø 27 cm, innerer Ring Ø 18 cm, Lieferung ohne Teller  
for plates max. Ø 27 cm, circle inside Ø 18 cm, delivery without dishes  
para platos máx. Ø 27 cm, aro interior Ø 18 cm, se entrega sin platos  
pour assiettes Ø 27 cm maxi., anneau intérieur Ø 18 cm, livré sans assiettes

METAL NON SLIP FEET

	Ø cm	↑ cm		€
33208	29 x 19,5	30	2 Teller Ø 27 cm innerer Ring Ø 18 cm	29,00
33209	29 x 19,5	43	3 Teller Ø 27 cm innerer Ring Ø 18 cm	36,00

**Serviergestell**

serving stand  
soporte platos  
présentoir à assiettes

**METAL  
CHROME  
PLATED**

für 3 Teller max. Ø 27 cm, innerer Ring Ø 18 cm  
for 3 plates max. Ø 27 cm, circle inside Ø 18 cm  
para 3 platos Ø 27 cm, aro interior Ø 18 cm  
pour 3 assiettes maxi Ø 27 cm, anneau intérieur Ø 18 cm

	cm	↑ cm	€
33217	33 x 24	43	52,00

**Serviergestell**

serving stand  
soporte platos  
présentoir à assiettes

**METAL  
CHROME  
PLATED**
**NON  
SLIP  
FEET**

für 3 Teller max. Ø 17 cm, innerer Ring Ø 10,5 cm  
for 3 plates max. Ø 17 cm, circle inside Ø 10,5 cm  
para 3 platos Ø 17 cm, aro interior Ø 10,5 cm  
pour 3 assiettes maxi Ø 17 cm, anneau intérieur Ø 10,5 cm

	cm	↑ cm	Farbe / colour	€
33215	18,5 x 15,5	26		25,60
33211	18,5 x 15,5	26		28,00

für 3 Teller max. Ø 27 cm, innerer Ring Ø 18 cm  
for 3 plates max. Ø 27 cm, circle inside Ø 18 cm  
para 3 platos Ø 27 cm, aro interior Ø 18 cm  
pour 3 assiettes maxi Ø 27 cm, anneau intérieur Ø 18 cm

	cm	↑ cm	Farbe / colour	€
33220	29 x 19,5	43		42,00
33212	29 x 19,5	43		45,00

**Etagère „FINESSE“**

etagère  
frutero  
étagère

**18/0  
STAINLESS  
STEEL**

**made in  
Germany**

vergoldeter Messing-Kugelgriff  
gold plated knob  
botón dorado  
bouton doré

	Ø cm	↑ cm		€
33248	48 / 38 / 32	50	3-stufig / 3-tier 3 alturas / 3 niveaux	99,00
33238	38 / 32	30	2-stufig / 2-tier 2 alturas / 2 niveaux	62,00



## SERVING STANDS



### 2-stufige Etagère „IRON“

2-tier tray  
bandeja con dos alturas  
étagère carré 2 hauteurs

1 Gestell aus schwarzem Metall  
2 Akazienholzplatten: Ø 23 cm, H: 1,5 cm / Ø 30 cm, H: 2,5 cm  
2 Beschriftungsschilder 15 x 10,5 cm

1 soporte metálico negro  
2 tablas de madera de acacia: Ø 23 cm, H: 1,5 cm / Ø 30 cm, H: 2,5 cm  
2 inscriptions 15 x 10,5 cm

1 support métallique noir  
2 panneaux en bois d'acacia: Ø 23 cm, H: 1,5 cm / Ø 30 cm, H: 2,5 cm  
2 étiquettes d'inscription 15 x 10,5 cm



	cm	↑ cm	€
30334	47 x 30	44	78,00



Präsentationsmöglichkeiten  
presentation examples

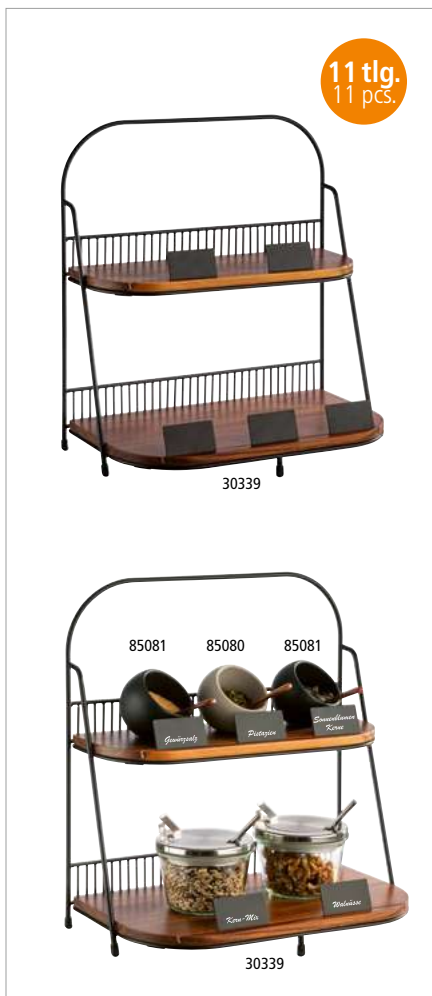

### 2-stufige Etagère

2-tier tray  
soporte 2 alturas  
étagère 2 niveaux

1 Gestell aus schwarzem Metall, mit Antirutschfüßchen,  
2 herausnehmbare Bretter aus geöltem Akazienholz (34,5 x 20,5 x 1,5 cm) / (34,5 x 13 x 1,5 cm)  
8 Beschriftungsschilder (6 x 4 cm)

1 frame made of black metal with non-slip feet,  
2 removable trays made of acacia wood (34,5 x 20,5 x 1,5 cm) / (34,5 x 13 x 1,5 cm)  
8 labelling plates (6 x 4 cm)

1 soporte metálico, negro con pies antideslizantes,  
2 bandejas extraíbles de madera de acacia (34,5 x 20,5 x 1,5 cm) / (34,5 x 13 x 1,5 cm)  
8 etiquetas (6 x 4 cm)

1 support métallique noir avec pieds antidérapants,  
2 planches amovibles en bois d'acacia (34,5 x 20,5 x 1,5 cm) / (34,5 x 13 x 1,5 cm)  
8 étiquettes (6 x 4 cm)



	cm	↑ cm	€
30339	35,5 x 21	40	62,00

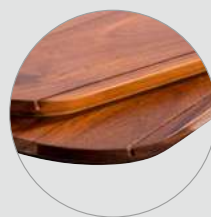

geöltes Akazienholz  
oiled acacia wood



1 x Gestell / 1 x frame



2 x Korb / 2 x basket

5 tlg.  
5 pcs.

2 x Tablett / 2 x tray



Haube / cover 11056



Korb / basket 30337



Tablett / tray 85099



Tablett / tray 30338

## 2-stufige Etagère „ALL-ROUNDER“, 5-teilig

2-tier tray, 5 pcs.

soporte 2 alturas, set de 5

étagère 2 niveaux, set de 5

5 teiliges Set:

- 1 Gestell aus schwarzem Metall, mit Antirutschfüßchen,
- 2 Körbe aus Metall schwarz je 29 x 16 cm, H: 7 cm,
- 2 herausnehmbare Bretter aus geöltem Akazienholz je 28,5 x 15,5 cm, H: 1,5 cm

5 pcs.:

- 1 frame made of black metal with non-slip feet,
- 2 removable baskets of black metal each 29 x 16 cm, H: 7 cm,
- 2 boards of oiled acacia wood each 28,5 x 15,5 cm, H: 1,5 cm

set de 5:

- 1 soporte metálico, negro con pies antideslizantes,
- 2 cestas metálicas negras, cada una de 29 x 16 cm, H: 7 cm,
- 2 tablas de madera de acacia aceiteada 28,5 x 15,5 cm, H: 1,5 cm

set de 5:

- 1 support métallique noir avec pieds antidérapants,
- 2 paniers métalliques noirs, chacune 29 x 16 cm, H: 7 cm,
- 2 planches d'acacia huilé, chacune 28,5 x 15,5 cm, H: 1,5 cm

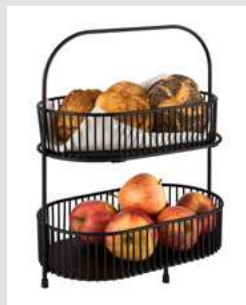

	cm	↑ cm	€
30336	31 x 17	37,5	62,00

Präsentationsmöglichkeiten  
presentation examplesgeöltes Akazienholz  
oiled acacia woodmit Antirutschfüßchen  
with non-slip feet

Korb / basket / cesta / corbeille

	cm	↑ cm	Farbe / colour	€
30337	29 x 16	6,5	■	19,00

Servierbrett aus Akazienholz / serving board of acacia wood / tabla de servio de madera de acacia / planche de service en bois d'acacia

	cm	↑ cm	Farbe / colour	€
30338	28,5 x 15,5	3,5	■	8,20

Melamintablett / melamine tray / bandeja de melamina / plateau en mélamine

	cm	↑ cm	Farbe / colour	€
85099	28,0 x 15,5	1,0	■	13,60

Haube / cover / campana / cloche

	cm	↑ cm	€
11056	26,0 x 12,0	10,0	6,00

## SERVING STANDS



### Buffetgestell „BIRDCAGE“

buffet stand  
soporte para buffet  
présentoir buffet



Gestell aus schwarzem Metall, inklusive 2 Akazienholzplatten

black metal frame, incl. 2 acacia wood panels

soporte metálico negro, con 2 tablas de madera de acacia

support métallique noir, avec 2 panneaux en bois d'acacia

	Ø cm	↑ cm	€
33206	26	54	54,00

### Ersatz-Holzplatte

spare wooden panel

tabla de madera de recambio

panneau en bois de rechange

	Ø cm	↑ cm	€
33207	25	1	15,00

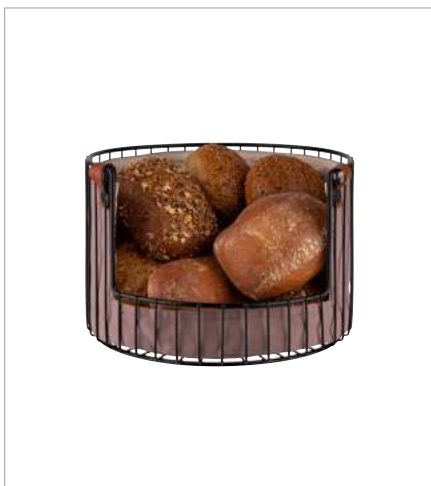

### Brot- und Obstkorb

basket for bread or fruits  
cesta para pan o fruta  
corbeille à pain ou à fruits



inklusive Tasche aus Baumwolle, beige grau, maschinenwaschbar bis 30 Grad

incl. bag made of cotton, beige, grey, machine washable up to 30°C

bolsa incluida, de algodón, beige, gris, lavable a máquina hasta 30°C

sac inclus en coton, beige, gris, lavable en machine jusqu'à 30°C

	Ø cm	↑ cm	€
30209	27,5	18,5	32,00



stapelbar  
stackable



rutschfest inklusive Klipp  
non-slip, includes clip



### Brot- und Obstkorb „URBAN“

basket for bread or fruits  
cesta para pan o fruta  
corbeille à pain ou à fruits



	Ø cm	↑ cm	€
30211	22,5	28	26,00

**Eierkorb „OVO“**

egg basket  
cesta de huevos  
panier à oeufs



**Gestell aus Metall, EPP-Box sorgt für perfekte Wärmeisolierung, Eier werden lange warm gehalten, inklusive waschbarem Stoffeinsatz**

metal frame, EPP box ensures perfect heat insulation, Eggs are kept warm for a long time, including washable fabric insert  
estructura de metal, la caja de EPP garantiza un perfecto aislamiento térmico, los huevos se mantienen calientes durante mucho tiempo, incluye inserto de tela lavable  
structure en métal, la boîte EPP assure une isolation thermique parfaite, les oeufs sont maintenus au chaud pendant longtemps, insert en tissu lavable inclus

	Ø cm	↑ cm	€
30480	23	31	34,00

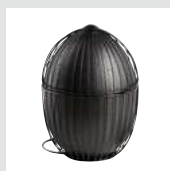

für ca. 35 Eier  
for approx. 35 eggs

**Serviergestell, 2-stufig „MORRA“**

servicing stand, 2-tier  
soporte platos, 2 alturas  
présentoir, 2 hauteurs



**3 tlg. Set: 1 Gestell aus Akazienholz, 2 Schieferplatten**

3 pcs.: 1 stand acacia wood, 2 slate trays

set de 3: 1 soporte madera de acacia, 2 bandejas de pizarra

set de 3: 1 présentoir en bois d'acacia, 2 plateaux en ardoise naturelle



**zusammenklappbar  
foldable**

	cm	↑ cm	€
00958	36,5	34 x 26,5	37,00

**3-stufige Etagère „MORRA“**

3-tier tray  
bandeja con tres alturas  
étagère carré 3 hauteurs



**Naturschieferplatten Ø 30 / 25 / 20 cm**

natural slate trays Ø 30 / 25 / 20 cm

losas de pizarra natural Ø 30 / 25 / 20 cm

plaques d'ardoise naturelle Ø 30 / 25 / 20 cm

	Ø cm	↑ cm	* mm	€
00960	30 / 25 / 20	34	6 - 9	29,00

**2-stufige Etagère „MORRA“**

2-tier tray  
bandeja dos alturas  
étagère carré 2 hauteurs



**Naturschiefer Ø 25 / 20 cm**

natural slate tray Ø 25 / 20 cm

bandeja de pizarra natural Ø 25 / 20 cm

plateau ardoise naturelle Ø 25 / 20 cm

	Ø cm	↑ cm	* mm	€
00989	25 / 20	24	6 - 9	14,80

## SERVING STANDS



79553

Hygieneschutz  
11557 / 11558

### Brezel- oder Wurstständer

pretzel-/ sausage stand  
soporte para pretzels/ embutidos  
support à bretzel ou à saucissons



Verkaufsständer Buchenholz versiegelt, bestens geeignet für die Präsentation von Brezeln, Würstchen, etc., Fuß Ø 22 cm

beech wood, ideal to present pretzels, sausages, etc., base Ø 22 cm

soporte de madera de haya, ideal para presentar pretzels, salchicas, etc., base Ø 22 cm

support en bois de hêtre, pour la présentation de bretzels, saucisses, etc. pied Ø 22 cm

	Ø cm	↑ cm	€
79553	28	50	22,40

### Hygieneschutz für Brezelständer / hygienic cover / campana higiénica antialiento / pare-haleine

	cm	↑ cm	€
11557	20 x 20 x 20	50	22,00
11558	15 x 20 x 15	50	20,00

### Hobel für Käse und Schokolade

cheese / choco curler  
rizador para queso y chocolate  
frisette pour fromage et chocolat



3-teilig: Platte Buchenholz versiegelt Ø 22 cm mit senkrechtem Stift  
+ Hobel 7 cm + Haube Ø 15 x 10 cm, für Käse und Schokolade

3 pcs.: wooden base Ø 22 cm with vertical bolt + plough 7 cm  
+ cover Ø 15 x 10 cm, for cheese and chocolate

set de 3: base de madera Ø 22 cm, con eje vertical de 7 cm

+ campana Ø 15 x 10 cm, para „rizar“ queso y chocolate

set de 3: base bois Ø 22 cm, axe vertical ht. 7 cm, cloche Ø 15 x ht 10 cm,  
pour „friser“ le fromage ou le chocolat

	Ø cm	↑ cm	€
50002	22	15	21,00



inklusive Haube  
including cover

**Buffetständer „ACACIA“**

buffet stand  
soporte para buffet  
présentoir buffet

Akazienholz geölt / acacia wood oiled / madera de acacia aceitada / bois d'acacia huilé



	Ø cm	↑ cm		€
15620	20,0	10,5		31,00
15621	30,5	15,0		53,00
15622	30,5	20,0		58,00

**Frischhaltehaube / cover / campana / cloche**

	Ø cm	↑ cm	fits to	€
06520	30	22	15621, 15622	37,00

**Frischhaltehaube / cover / campana / cloche**

	Ø cm	↑ cm	fits to	€
06512	30	11,5	15621, 15622	8,20

**Buffetständer „ACACIA“**

buffet stand  
soporte para buffet  
présentoir buffet

Akazienholz geölt / acacia wood oiled / madera de acacia aceitada / bois d'acacia huilé



	cm	↑ cm	GN	€
15623	53 x 16,2	20	2/4	63,00

**GN Abdeckhaube / GN cover / GN campana/ GN cloche**

	cm	↑ cm	GN	€
11044	53 x 16,2	10,5	2/4	23,00



# CUTTING BOARDS



## Brottschneidebrett „PROFI“

cutting board  
tabla de cortar  
planche à découper

Eichenholz / oak wood / mader de roble / bois de chêne



	cm	↑ cm		€
00806	58 x 37,5	4		118,00



## GN 1/1 Brottschneidebrett „VALO“

GN 1/1 cutting board  
GN 1/1 tabla de cortar  
planche à découper GN 1/1

massives Brottschneidebrett mit Antirutschfüßchen für sicheren Halt

solid cutting board with non-slip feet for a secure hold

tabla de cortar pan maciza con pies antideslizantes para una sujeción segura

planche à découper massive avec pieds antidérapants pour une bonne stabilité

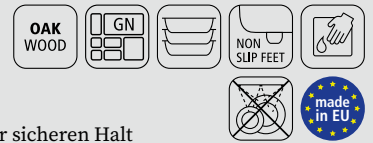

	cm	↑ cm	GN	€
00764	53 x 32,5	3,5	1/1	100,00



## Brotmesser

bread knife  
cuchillo para pan  
couteau à pain

Brotmesser aus rostfreiem Edelstahl, dreifach genietet, mit Griff aus Buchenholz

bread knife made of stainless steel, triple riveted, with beech wood handle

cuchillo para pan de acero inoxidable, triple remachado, con mango de madera de haya

couteau à pain en acier inox, triplement riveté, avec manche en bois de hêtre



	→ cm	€
88990	34	16,00

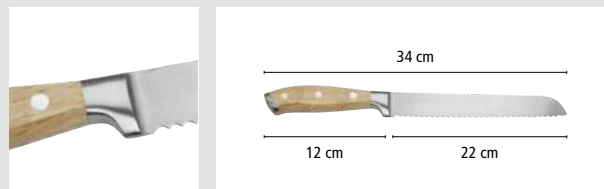



**Brotschneidebrett**

cutting board  
tabla de cortar  
planche à découper



Walnussholz / walnut wood / madera de nogal / bois de noyer

	cm	↑ cm	GN	€
00911	35,4 x 32,5	3,5	2/3	84,00



praktisches Krümelfach  
practical crump shelf



**Brotschneidebrett „LETTER“**

cutting board  
tabla de cortar  
planche à découper



Akazienholz / acacia wood / madera de acacia / bois d'acacia

	cm	↑ cm	GN	€
00886	48 x 34	3,5		34,00



praktisches Krümelfach  
practical crump shelf



**Brotschneidebrett**

cutting board  
tabla de cortar  
planche à découper



Akazienholz / acacia wood / madera de acacia / bois d'acacia

	cm	↑ cm	GN	€
00883	47,5 x 32,0	2		30,00
00884	53,0 x 32,5	2	1/1	31,00
00885	60,0 x 40,0	2		36,00



praktisches Krümelfach  
practical crump shelf



**Brotschneidebrett**

cutting board  
tabla de cortar  
planche à découper



Rubberwood / rubberwood / madera de caucho / bois d'hévéa

	cm	↑ cm	GN	€
00955	47,5 x 32,0	2		27,00
00956	53,0 x 32,5	2	1/1	29,00
00957	60,0 x 40,0	2		34,00



praktisches Krümelfach  
practical crump shelf

# CUTTING BOARDS



00954  
Box

00953  
Schneidebrett

83615  
Tablett



Tablett „BROTSTATION“  
tray  
bandeja  
plateau



	cm	↑ cm	€
83615	59,5 x 35,5	3,5	42,00

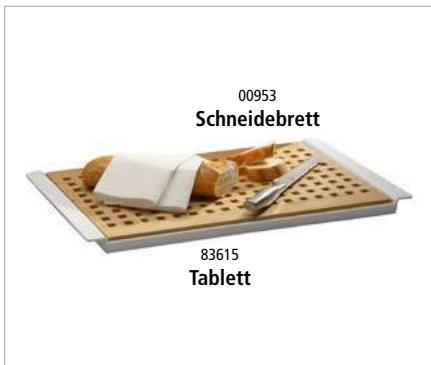

00953  
Schneidebrett

83615  
Tablett

Brotschneidebrett „BROTSTATION“  
cutting board  
tabla de corte  
planche à découper



	cm	↑ cm	€
00953	52 x 34	2	37,00

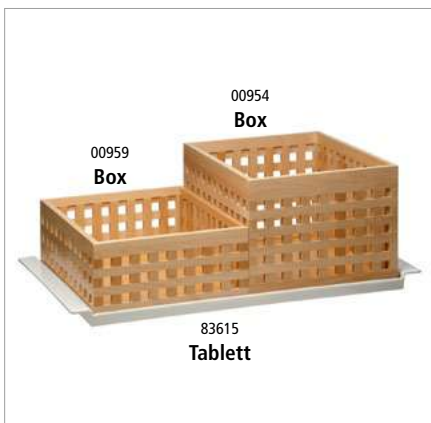

00954  
Box

00959  
Box

83615  
Tablett

Box „BROTSTATION“  
box  
caja de pan  
boîte à pain



	cm	↑ cm	€
00959	34 x 26	12,5	52,00
00954	34 x 26	20,0	64,00



**Schneidebrett**

cutting board  
tabla de cortar  
planche à découper

**Eichenholz, geölt, mit Antirutsch-Füßchen**

oak wood oiled, with non-slip feet  
madera de roble aceitada, con pies antideslizantes  
bois de chêne huilé, avec pieds antidérapants



	cm	↑ cm	Farbe / colour	€
00762	58,5 x 35	2		72,00

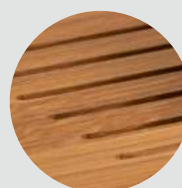

**Präsentationsmöglichkeit 2-teilig**  
presentation example 2-piece

**Eichenholz**  
oak wood



**Schneidebrett**

cutting board  
tabla de cortar  
planche à découper

**Walnuss, geölt, mit Antirutsch-Füßchen**

walnut wood oiled, with non-slip feet  
madera de nogal aceitada, con pies antideslizantes  
bois noyer huilé, avec pieds antidérapants



	cm	↑ cm	Farbe / colour	€
00763	58,5 x 35	2		90,00

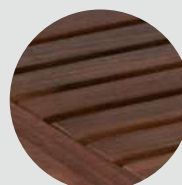

**Präsentationsmöglichkeit 2-teilig**  
presentation example 2-piece

**Walnuss**  
walnut wood



**Tablett / Basis**

tray / base  
bandeja / base  
plateaux / base

**passendes Schneidebrett Nr. 762, 763**

suitable cutting board art. 762, 763  
tabla de cortar adecuada art. 762, 763  
planche à découper appropriées art. 762, 763



	cm	↑ cm	€
85225	67 x 38	4	78,00

# BUFFET BOARDS „OKLA“



## Buffetbrett „OKLA“

buffet board  
tabla de buffet  
planche de buffet

aus geöltem Eichenholz, Safrinne, mit Antirutschfüßchen

made of oiled oak, with juice groove and non-slip feet

de madera de roble aceitada, con ranura para líquidos y pies antideslizantes

en bois chêne huilé, avec rigole et pieds antidérapants



	Ø cm	↑ cm	€
00805	33	4,5	73,00
00816	39	4,5	118,00

## Frischhaltehaube / cover / campana / cloche



	Ø cm	↑ cm	fits to	€
06512	30	11,5	00805	8,20

## Frischhaltehaube / cover / campana / cloche



	Ø cm	↑ cm	fits to	€
06520	30	22	00805	37,00
06521	36	27	00816	74,00



## Buffetbrett „OKLA“

buffet board  
tabla de buffet  
planche de buffet

aus geöltem Eichenholz, Safrinne, mit Antirutschfüßchen

made of oiled oak, with juice groove and non-slip feet

de madera de roble aceitada, con ranura para líquidos y pies antideslizantes

en bois chêne huilé, avec rigole et pieds antidérapants



	cm	↑ cm	€
00807	38 x 32,0	4,5	78,00
00806	58 x 37,5	4,5	118,00

## Rolltophaube / rolltop cover / campana rolltop / cloche rolltop



	Ø cm	↑ cm	fits to	GN	€
11016	53,0 x 32,5	19	00806	1/1	64,00

# MODULO



## Buffet Box „MODULO“

buffet box  
caja buffet  
boîte à buffet



Eichenholz, geölt, Innenmaße: 15,5 x 10 cm  
oak wood oiled, interior dimensions: 15,5 x 10 cm  
madera de roble aceitada, medidas int.: 15,5 x 10 cm  
bois de chêne huilé, dimensions int.: 15,5 x 10 cm

	cm	↑ cm	€
11728	17,5 x 15,5	12,5	32,00



stapelbar  
stackable

Präsentationsmöglichkeit  
presentation example



## Buffet Box „MODULO“

buffet box  
caja buffet  
boîte à buffet



aus geöltem Eichenholz, 2 Fächer je: 25 x 16 cm, mit 2 Griffmulden  
made of oiled oak wood, 2 compartments: each 25 x 16 cm, with 2 recessed grips  
de madera de roble aceitada, 2 compartimentos de 25 x 16 cm, con 2 asas empotradas  
en bois de chêne huilé, 2 compartiments: chacun 25 x 16cm, avec 2 poignées encastrées

	cm	↑ cm	€
11729	35 x 31	12,5	60,00



stapelbar  
stackable

Präsentationsmöglichkeit  
presentation example

## MULTI RACKS



### Gestell „MULTI RACK“

rack  
marco  
châssis

- 1 Gestell schwarz, matt
- Schütten aus grau gefrostedem Kunststoff
- 1 frame matt
- bowls frosted plastic
- 1 soporte mate
- cuencos de plástico glaseado
- 1 support mat
- bols en plastique mat



	cm	↑ cm	ltr.	€
11413	19,5 x 28	41	1	50,00
11414	19,5 x 33	53	1	64,00

### Ergänzung für alle Gestelle „MULTI RACK“

supplement for all racks „MULTI RACK“  
suplemento para todas las estanterías „MULTI RACK“  
complément pour tous les supports „MULTI RACK“



Schütte / canister / cuenco / bol

	cm	↑ cm	ltr.	€
11411	19,5 x 16,5	10,5	1	7,20



### Gestell „MULTI RACK“

rack  
marco  
châssis

- 1 Gestell matt poliert
- Schütten aus transparent gefrostedem Kunststoff
- 1 frame matt polished
- bowls frosted plastic
- 1 soporte pulido mate
- cuencos de plástico glaseado
- 1 support poli mat
- bols en plastique mat



	cm	↑ cm	ltr.	€
11444	19,5 x 28	41	1	48,00
11446	19,5 x 33	53	1	62,00

### Ergänzung für alle Gestelle „MULTI RACK“

supplement for all racks „MULTI RACK“  
suplemento para todas las estanterías „MULTI RACK“  
complément pour tous les supports „MULTI RACK“



Schütte / canister / cuenco / bol

	cm	↑ cm	ltr.	€
11455	19,5 x 16,5	10,5	1	7,20



**Dressingtopf „FROSTFIRE“**

dressing pot  
salsera  
pot à sauce

**Antihafbeschichtung**  
non stick coating  
antiadherente  
revêtement anti-adhésif



	Ø cm	↑ cm	ltr.	Farbe / colour	€
36140	11,5 / 11	15	1,4	black / silver	18,60



**Dressingtopf-Station**

wooden station for 3 dressing pots  
expositor de madera para 3 salseras  
présentoir en bois pour 3 pots à sauce

**inklusive 3 Beschriftungsschilder aus Metall / including 3 metal labels / con 3 etiquetas de metal / avec 3 étiquettes métalliques**



	cm	↑ cm	fits to	€
84863	40 x 16	9	83311, 83867	31,00



**Dressingtopf „PASTELL“**

dressing pot  
salsera  
pot à sauce



	cm	↑ cm	ltr.	€
84860	13	19,5	1,5	22,00



**Dressingtopf „CASUAL“**

dressing pot  
salsera  
pot à sauce



	cm	↑ cm	ltr.	Farbe / colour	€
83867	12	21,5	1	white	29,80
83868	12	21,5	1	black	29,80



**Dressingtopf**

dressing pot  
salsera  
pot à sauce

**Deckel mit Löffelaussparung / cover notched for spoon / tapa agujereada para el cucharón / couvercle avec espace pour la louche**



	Ø cm	↑ cm	ltr.	€
83310	17,0	15	2,0	27,00
83311	13,0	13	0,8	14,80

# JARS

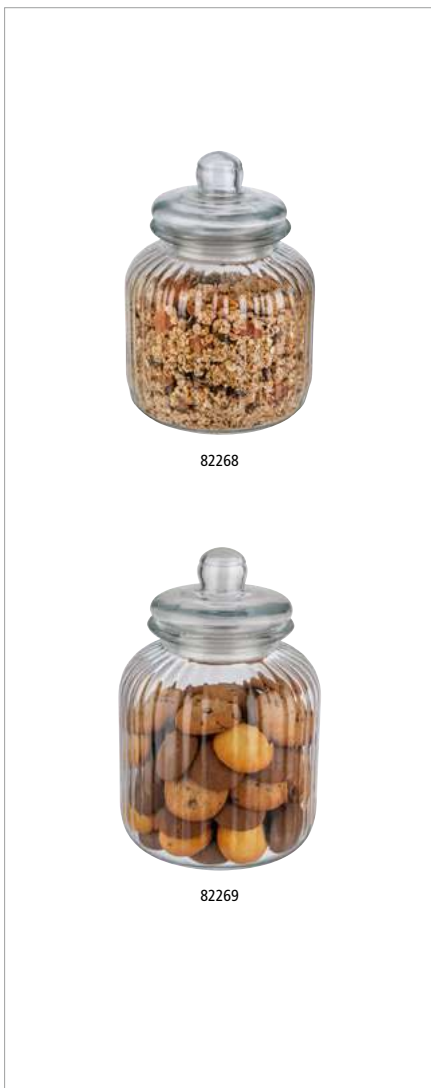

## Vorratsglas mit Deckel „COOKIEGO“

jar with lid  
bote con tapa  
pot en verre avec couvercle



**inklusive Glasdeckel mit Dichtung, somit bleibt Ihre Ware frisch**  
including glass lid with seal, thus, your goods remain fresh  
con tapa de vidrio con junta, por lo tanto, sus productos permanecen frescos  
y compris couvercle en verre avec joint, ainsi, vos marchandises restent fraîches

	Ø cm	↑ cm	ltr.	€
82268	17,0	24,5	3,0	13,00
82269	17,5	27,0	3,7	15,00

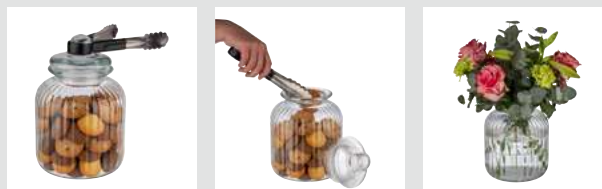



82265 1 ltr.



82266 1,2 ltr.



82267 1,5 ltr.

**Vorratsglas mit Deckel „NOTE“**

jar with lid  
bote con tapa  
pot en verre avec couvercle

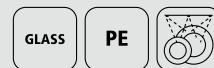

**inklusive Glasdeckel mit Dichtung und Beschriftungsfeld, somit bleibt Ihre Ware frisch**  
including glass lid with seal and labeling field, thus, your goods remain fresh  
con tapa de vidrio con junta y campo de etiquetado, por lo tanto, sus productos permanecen frescos  
y compris couvercle en verre avec joint et le domaine de l'étiquetage, ainsi, vos marchandises restent fraîches

	Ø cm	↑ cm	ltr.	€
82265	11,0	18,0	1,0	7,20
82266	11,5	19,5	1,2	8,00
82267	12,0	21,0	1,5	10,60



**Kreidestift zum Beschriften**  
chalk marker for writing  
S. 348



82255 1,0 ltr.



82256 2,0 ltr.



82257 2,5 ltr.

**Vorratsglas mit Deckel „WOODY“**

jar with lid  
bote con tapa  
pot en verre avec couvercle



**Glasbehälter mit Holzdeckel, aromadichter Verschluss**  
glass container, aroma-tight screw cap  
recipiente de cristal, tapa con cierre hermético para conservar el aroma  
récipient en verre, couvercle avec fermeture hermétique pour conserver l'arôme

	cm	↑ cm	ltr.	€
82255	14 x 14	11,0	1,0	11,50
82256	14 x 14	17,0	2,0	12,60
82257	14 x 14	21,5	2,5	14,40



**Holzdeckel aus Kiefernholz mit Silikondichtung**  
wooden lid from pine wood with silicone gasket

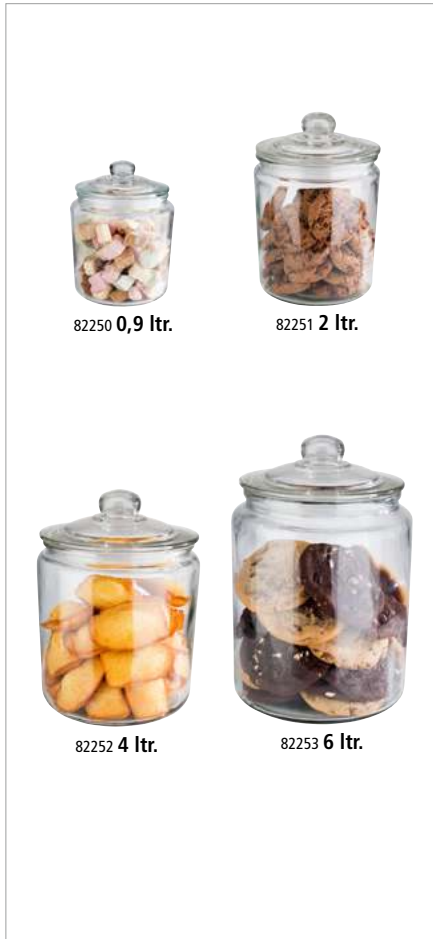

**Vorratsglas mit Deckel „CLASSICO“**

jar with lid  
bote con tapa  
pot en verre avec couvercle



**inklusive Glasdeckel mit Dichtung, somit bleibt Ihre Ware frisch**  
including glass lid with seal, thus, your goods remain fresh  
con tapa de vidrio con junta, por lo tanto, sus productos permanecen frescos  
y compris couvercle en verre avec joint, ainsi, vos marchandises restent fraîches

	Ø cm	↑ cm	ltr.	€
82250	11,5	16,0	0,9	7,80
82251	14,0	21,5	2,0	13,20
82252	18,0	26,0	4,0	21,60
82253	20,0	30,0	6,0	25,40



**Präsentationsmöglichkeit**  
presentation example



**Vorratsglas mit luftdichtem Klappdeckel**

jar with airtight cover  
bote con cierre hermético  
pot en verre avec fermeture hermétique



	cm	↑ cm	ltr.	€
82328	12 x 12	22	2	9,00

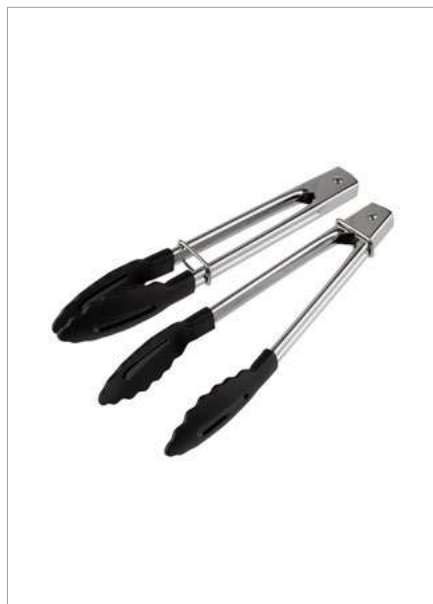

**Mini-Universalzange, 2er Set**

mini all-purpose tongs, 2 pcs.  
mini pinzas multiusos, set de 2  
mini pince multi-usages, set de 2

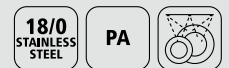

**Edelstahl poliert, Greifer aus Polyamid, inklusive Haltering**  
polished stainless steel, polyamide gripper, including retaining ring  
acero inoxidable pulido, pinzas de poliamida, anillo de retención incluido  
acier inox poli, pinces en polyamide, anneau de retenue inclus

	→ cm	pcs.	€ / set
75870	18	2	8,40





**seitlich gestellt**  
placed sideways  
**1 ltr.**



**hochkant gestellt**  
placed upright  
**2,2 ltr.**

**Vorratsglas mit Deckel**

jar with lid  
bote con tapa  
pot en verre avec couvercle

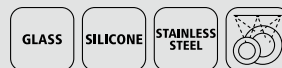

**Schraubdeckel mit aromadichtem Verschluss, Edelstahlöffel mit magnetischem Silikongriff**

tight cover, stainless steel spoon with magnetic silicone handle  
tapa a rosca con cierre hermético, cuchara de acero inoxidable con mango de silicona magnético  
couvercle à vis avec fermeture hermétique, cuillère en acier inox avec manche de silicone aimanté

	cm	↑ cm	ltr.	€
00636	17 x 12,5	18	1 - 2,2	15,00



**seitlich gestellt**  
placed sideways  
**1 ltr.**



**hochkant gestellt**  
placed upright  
**2,2 ltr.**

**Vorratsglas mit Deckel**

jar with lid  
bote con tapa  
pot en verre avec couvercle



**mit Schraubdeckel, aromadichtem Verschluss**

aroma-tight screw cap  
tapa a rosca para conservar el aroma  
couvercle à vis pour conserver l'arôme

	cm	↑ cm	ltr.	€
00637	17 x 12,5	18	1 - 2,2	10,00

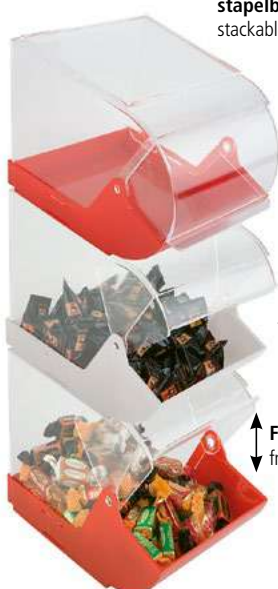

**stapelbar**  
stackable

11884

11885

**Frontklappe**  
front lid

**Universalbox**

box / sweetbox  
caja dispensadora  
boîte distributrice



**ideal als Verkaufsbox, mit Frontdeckel**

best to present sweets etc., all-purpose, with front lid  
la perfecta solución para presentar golosinas, universal, con tapa frontal  
la solution idéale pour les friandises et autres, universel, avec couvercle frontal

	cm	↑ cm	Farbe / colour	€
11884	23 x 14,5	15	White	14,00
11885	23 x 14,5	15	Red	14,00

**NEW** BULQ



75946



75947



75948

Löffel „BULQ“

spoon  
cuchara  
cuillère



die angeschrägte Form sorgt für eine komfortable Entnahme und ein sauberes Servieren  
the bevelled shape ensures easy removal and clean serving  
la forma biselada facilita la extracción y el servicio limpio  
la forme biseautée permet un prélèvement confortable et un service propre

	cm	→ cm	ml	Farbe / colour	€
75946	8,5 x 8,5	23	120	vintage-look	10,00
75947	8,5 x 8,5	23	120	vintage-look gold (PVD)	11,00
75948	8,5 x 8,5	23	120	vintage-look copper (PVD)	11,00

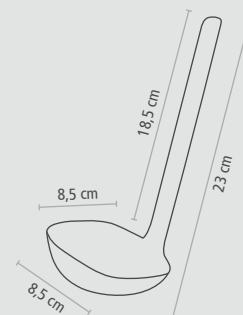



**Löffel, 2er Set „BULQ“**

spoon, set of 2  
cuchara, set de 2  
cuillère, set de 2



die angeschrägte Form sorgt für eine komfortable Entnahme und ein sauberes Servieren  
the bevelled shape ensures easy removal and clean serving  
la forma biselada facilita la extracción y el servicio limpio  
la forme biseautée permet un prélèvement confortable et un service propre

	cm	→ cm	ml	Farbe / colour		pcs.	€/ set
75943	6,5 x 6,5	17,5	60		vintage-look	2	13,60
75944	6,5 x 6,5	17,5	60		vintage-look gold (PVD)	2	15,00
75945	6,5 x 6,5	17,5	60		vintage-look copper (PVD)	2	15,00

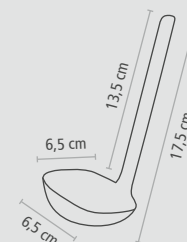

**Löffel, 4er Set „BULQ“**

spoon, set of 4  
cuchara, set de 4  
cuillère, set de 4



die angeschrägte Form sorgt für eine komfortable Entnahme und ein sauberes Servieren  
the bevelled shape ensures easy removal and clean serving  
la forma biselada facilita la extracción y el servicio limpio  
la forme biseautée permet un prélèvement confortable et un service propre

	cm	→ cm	ml	Farbe / colour		pcs.	€/ set
75940	4,5 x 4,5	12,5	20		vintage-look	4	16,50
75941	4,5 x 4,5	12,5	20		vintage-look gold (PVD)	4	18,00
75942	4,5 x 4,5	12,5	20		vintage-look copper (PVD)	4	18,00



# 5 STARS



NEW



88340 2 ltr.



88341 2 ltr.



88342 2 ltr.

Brat- und Servierpfanne „5 STARS“  
 frying and serving pan  
 poêle à frire et à servir  
 sartén para freír y servir



	Ø cm	↑ cm	ltr.	Farbe / colour	€
88340	29	5,5	2		52,00
88341	29	5,5	2		52,00
88342	29	5,5	2		52,00

NEW



88330 0,35 ltr.



88331 0,35 ltr.



88332 0,35 ltr.

Mini-Topf mit Deckel „5 STARS“

mini pot with lid  
mini olla con tapa  
mini casserole avec couvercle

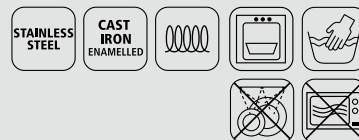

	Ø cm	↑ cm	ltr.	Farbe / colour	€
88330	11	6,5 / 9	0,35		24,00
88331	11	6,5 / 9	0,35		24,00
88332	11	6,5 / 9	0,35		24,00



NEW



88333 0,45 ltr.



88334 0,45 ltr.



88335 0,45 ltr.

Mini-Topf mit Deckel „5 STARS“

mini pot with lid  
mini olla con tapa  
mini casserole avec couvercle

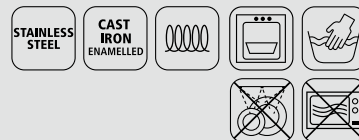

	Ø cm	↑ cm	ltr.	Farbe / colour	€
88333	14,5 x 11,5	6,5 / 9	0,45		26,00
88334	14,5 x 11,5	6,5 / 9	0,45		26,00
88335	14,5 x 11,5	6,5 / 9	0,45		26,00





Kochtopf mit Deckel „5 STARS“

cooking pot with lid  
olla con tapa  
marmite avec couvercle

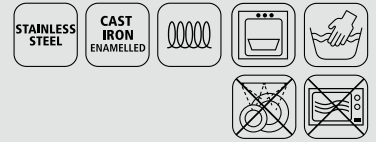

	Ø cm	↑ cm	ltr.	Farbe / colour	€
88302	25	11,5 / 17,5	4		69,00
88303	25	11,5 / 17,5	4		69,00
88313	25	11,5 / 17,5	4		69,00



inklusive Deckelhalter  
including lid holder



Kochtopf mit Deckel „5 STARS“

cooking pot with lid  
olla con tapa  
marmite avec couvercle

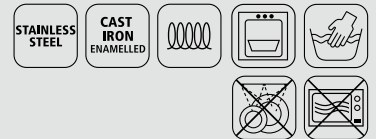

	Ø cm	↑ cm	ltr.	Farbe / colour	€
88306	28	13 / 20	6		79,00
88307	28	13 / 20	6		79,00
88315	28	13 / 20	6		79,00



inklusive Deckelhalter  
including lid holder



88300 2,5 ltr.



88301 2,5 ltr.



88312 2,5 ltr.

## Bräter mit Deckel „5 STARS“

roaster with lid  
cacerola con tapa  
cocotte avec couvercle

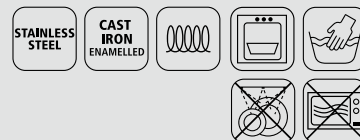

	Ø cm	↑ cm	ltr.	Farbe / colour	€
88300	25	7 / 13	2,5		63,00
88301	25	7 / 13	2,5		63,00
88312	25	7 / 13	2,5		63,00



inklusive Deckelhalter  
including lid holder



88304 3 ltr.



88305 3 ltr.



88314 3 ltr.

## Bräter mit Deckel „5 STARS“

roaster with lid  
cacerola con tapa  
cocotte avec couvercle

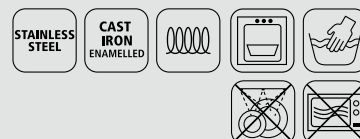

	Ø cm	↑ cm	ltr.	Farbe / colour	€
88304	28	7 / 13,5	3		74,00
88305	28	7 / 13,5	3		74,00
88314	28	7 / 13,5	3		74,00



inklusive Deckelhalter  
including lid holder



**Bräter mit Deckel „5 STARS“**

roaster with lid  
cacerola con tapa  
cocotte avec couvercle

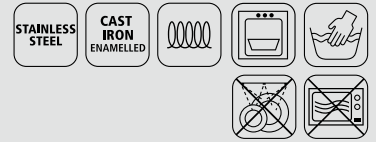

	cm	↑ cm	ltr.	Farbe / colour	€
88308	33 x 25	11 / 17,5	5		84,00
88309	33 x 25	11 / 17,5	5		84,00
88316	33 x 25	11 / 17,5	5		84,00



inklusive Deckelhalter  
including lid holder

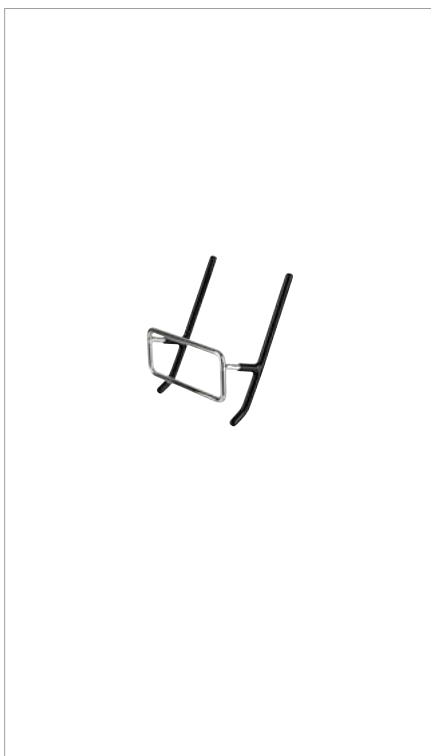

**Deckelhalter, 2er Set**

lid holder, 2 pcs.  
soporte para tapa, set de 2  
support de couvercle, set de 2



**mit Antirutschbeschichtung, für alle Töpfe mit Deckel einsetzbar, hitzebeständig**

with non-slip coating, suitable for all pots with lids, heat-resistant

con revestimiento antideslizante, apto para todas las ollas con tapa, resistente al calor

avec revêtement antidérapant, adapté à toutes les casseroles avec couvercle, résistant à la chaleur



	cm	↑ cm	Farbe / colour	pcs.	€ / set
88320	10,5 x 8,5	3,5		2	10,00

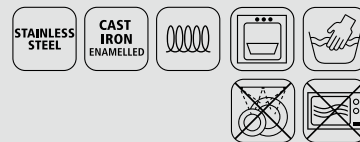

## Auflaufform „5 STARS“

casserole dish  
fuente para gratinar  
plat à four



	cm	↑ cm	ltr.	Farbe / colour	€
88310	33 x 24	6,5	3,5		58,00
88311	33 x 24	6,5	3,5		58,00
88317	33 x 24	6,5	3,5		58,00



88310 3,5 ltr.



88311 3,5 ltr.



88317 3,5 ltr.



# ORBIT



12344



12342



12343



12330



12335

## Chafing Dish, 4-teiliges Set „ORBIT“

chafing dish set, 4 pcs.  
chafing dish, set de 4  
chafing dish, set de 4



- 1 Topf (8 Liter), 1 Speisenbehälter (4 Liter), 1 Deckel mit Sichtfenster und 1 Deckelbremse
- 1 pot (8 litres), 1 foodpan (4 litres), 1 lid with glass insert and 1 automatic lid brake
- 1 olla (8 litros), 1 cubeta (4 litros), 1 tapa con ventanilla y 1 sistema de freno en la tapa
- 1 casserole (8 litres), 1 bac (4 litres), 1 couvercle avec fenêtre et 1 frein de couvercle

	Ø cm	↑ cm	ltr.	Farbe / colour	€
12344 <small>NEW</small>	30,5	17,5	4	■ sand	314,00
12342	30,5	17,5	4	■ vintage-look	314,00
12343	30,5	17,5	4	■ gold	314,00
12330	30,5	17,5	4	■ stainless steel	260,00
12335	30,5	17,5	4	■ copper	314,00



abnehmbarer Deckel  
removable lid



induktionsgeeignet  
suitable for induction

Ersatz-Speisenbehälter zu Chafing Dish / replacement foodpan for chafing dish / cubeta interior de repuesto para chafing dish / bac intérieur de remplacement pour le chafing dish

	Ø cm	↑ cm	ltr.	fits to	€
12329	30,5	8	4	12330, 12335, 12336, 12337, 12338, 12339, 12342, 12343, 12344	30,00



Ø 33 cm

8 ltr. Topf  
8 ltr. pot



Ø 30,5 cm

4 ltr. Speisenbehälter  
4 ltr. foodpan



Deckelbremse  
automatic lid break



Sandwich- / Kapsel-  
boden / sandwich base



12336



12337



12338



12339

### Chafing Dish, 4-teiliges Set „ORBIT“

chafing dish set, 4 pcs.  
chafing dish, set de 4  
chafing dish, set de 4



- 1 Topf (8 Liter), 1 Speisenbehälter (4 Liter), 1 Deckel mit Sichtfenster und 1 Deckelbremse
- 1 pot (8 litres), 1 foodpan (4 litres), 1 lid with glass insert and 1 automatic lid brake
- 1 olla (8 litros), 1 cubeta (4 litros), 1 tapa con ventanilla y 1 sistema de freno en la tapa
- 1 casserole (8 litres), 1 bac (4 litres), 1 couvercle avec fenêtre et 1 frein de couvercle

	Ø cm	↑ cm	ltr.	Farbe / colour	€
12336	30,5	17,5	4	yellow	314,00
12337	30,5	17,5	4	red	314,00
12338	30,5	17,5	4	black	314,00
12339	30,5	17,5	4	green	314,00

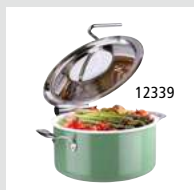

12339



abnehmbarer Deckel  
removable lid

induktionsgeeignet  
suitable for induction

Ersatz-Speisenbehälter zu Chafing Dish / replacement foodpan for chafing dish / cubeta interior de repuesto para chafing dish / bac intérieur de remplacement pour le chafing dish

	Ø cm	↑ cm	ltr.	fits to	€
12329	30,5	8	4	12330, 12335, 12336, 12337, 12338, 12339, 12342, 12343, 12344	30,00



Ø 33 cm

8 ltr. Topf  
8 ltr. pot



12329

Ø 30,5 cm

4 ltr. Speisenbehälter  
4 ltr. foodpan



Deckelbremse  
automatic lid break



Sandwich- / Kapselboden / sandwich base



82212 2 x 1,4 ltr.



82211 3 ltr.

### Porzellaneinsatz „ORBIT“

porcelain insert  
bandeja de porcelana  
bac en porcelaine



	Ø cm	↑ cm	ltr.	fits to	€
82212	29,5	9	2,8	12330, 12335, 12336, 12337, 12338, 12339, 12342, 12343, 12344	62,00
82211	29,5	9	3,0	12330, 12335, 12336, 12337, 12338, 12339, 12342, 12343, 12344	56,00

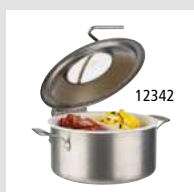

12342



82212

passend zur Serie „ORBIT“  
suitable for the „ORBIT“ series



# BONFIRE

Die Induktionsstation „Bonfire“ besticht durch ihr ausgefallenes Design: Holzscheite aus schwarzem Eschenholz und ein runder Aufbau aus schwarz-mattem Metall erinnern an ein stilisiertes Lagerfeuer. Ein Hingucker für das besondere Buffet.

The 'Bonfire' induction station impresses with its modern design: logs made of black ash wood and a round structure made of black matt metal are reminiscent of a stylised campfire. An elegant eye-catcher for professional buffet set-ups.

La estación de inducción «Bonfire» impresiona por su diseño moderno: los troncos de madera de fresno negro y la estructura redonda de metal negro mate recuerdan a una estilizada hoguera. Un elegante punto de atracción para el buffet profesional.

La station à induction « Bonfire » séduit par son design moderne: des bûches en bois de frêne noir et une structure ronde en métal noir mat rappellent un feu de camp stylisé. Un accroche-regard élégant pour un buffet professionnel.



## Induktionsstation „BONFIRE“

induction station  
estación de inducción  
station à induction

Induktionskochplatte Ø 24 cm, 900 Watt, inklusive Kabelfernbedienung,  
Leistung in Stufen regelbar, Ständer aus Eschenholz und Metall schwarz

induction hotplate Ø 24 cm, 900 watts, cable remote control,  
power adjustable in steps, black ash wood and metal stand

placa de inducción Ø 24 cm, 900 vatios, incluye mando a distancia por cable, potencia regulable en pasos, soporte de madera de fresno negro y metal negro

plaque de cuisson à induction Ø 24 cm, 900 watts, télécommande filaire incluse, puissance réglable par paliers, support en bois de frêne noir et métal noir

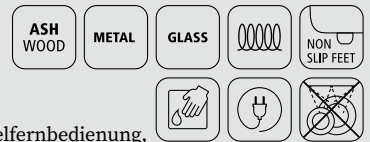

	Ø cm	↑ cm		€
12250	46,5	16	900 W	234,00



passend zur Serie „ORBIT“  
suitable for the „ORBIT“ series

2 tlg.  
2 pcs.



14050



14150

**Induktionsstation, 2-tlg. Set „VALO“**

induction station, 2-piece set  
estación de inducción, set de 2 piezas  
station à induction, set de 2 pièces



2-teiliges Set, bestehend aus:

- 1 Induktionskochplatte inklusive Kabelfernbedienung, Leistung in Stufen regelbar
- 1 Rahmen (wasserfest lackiert)

2 pcs., consisting of:

- 1 induction hotplate including cable remote control, power adjustable in steps
- 1 frame (waterproof lacquered)

set de 2, compuesto por:

- 1 placa de inducción con mando a distancia con cable, potencia regulable por niveles
- 1 marco (barnizado resistente al agua)

set de 2, composé de :

- 1 plaque à induction avec télécommande filaire, puissance réglable par paliers
- 1 cadre (vernis imperméable)

	cm	↑ cm		Farbe / colour	€
14050	38,5 x 38,5	10	2000 W		300,00
14150 <small>NEW</small>	38,5 x 38,5	10	2000 W		310,00



Kabelfernbedienung  
cable remote control

4 tlg.  
4 pcs.



**Induktionsstation, 4-tlg. Set „VALO“**

induction station, 4-piece set  
estación de inducción, set de 4 piezas  
station à induction, set de 4 pièces



4 teiliges Set:

- 1 Induktionskochplatte inklusive Kabelfernbedienung (Ø 24 cm, 900 Watt)
- 1 Metallständer schwarz
- 1 Rahmen (wasserfest lackiert)
- 1 Edelstahlrahmen

4 pcs. set:

- 1 induction hotplate including cable remote control (Ø 24 cm, 900 watt)
- 1 metal stand black
- 1 frame (waterproof lacquered)
- 1 stainless steel frame

set de 4:

- 1 placa de inducción con mando a distancia con cable (Ø 24 cm, 900 vatios)
- 1 soporte de metal negro
- 1 marco (barnizado resistente al agua)
- 1 marco de acero inoxidable

set de 4:

- 1 plaque à induction avec télécommande filaire (Ø 24 cm, 900 watts)
- 1 support métallique noir
- 1 cadre (vernis imperméable)
- 1 cadre en acier inox

	cm	↑ cm		€
12275	35,4 x 32,5	19	900 W	250,00

**Ersatzteile / replacement parts / piezas de repuesto / pièces de rechange**

	cm	↑ cm		€
12276	35,4 x 32,5	8,5	Holzrahmen / wooden frame	80,00
12272	29,5 x 26,5	1	Edelstahlrahmen / stainless steel frame	22,00
12295	Ø 24	-	900 Watt Induktionskochplatte / induction plate	139,00
15506	35,4 x 32,5	17,6	Buffetständer schwarz / buffet stand black	25,00

# NAPKIN HOLDERS



## Serviettenhalter „VALO“

napkin holder  
servilletero  
porte-serviettes

für ca. 100 Servietten mit 1/4 Falz, inklusive Beschwerer

for approx. 100 napkins with 1/4 fold, including weight

para aprox. 100 servilletas con 1/4 de pliegue, con barra de contrapeso

pour env. 100 serviettes pliées en 1/4, avec barre de contrepois



	cm	↑ cm	€
14092	19 x 19	16	59,00



stapelbar  
stackable

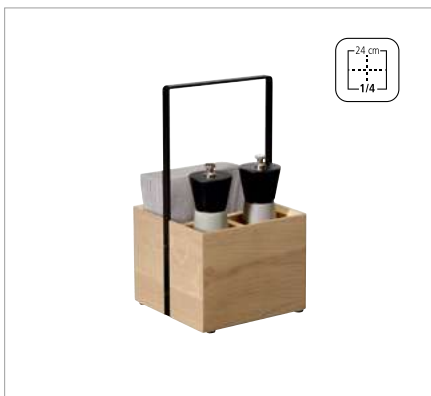

## Table Caddy „VALO“

table caddy  
caddy de mesa  
caddy de table

2 Fächer: 6 x 6 cm / 1 Fach: 6 x 13 cm

2 compartments: 6 x 6 cm / 1 compartment: 6 x 13 cm

2 compart. 6 x 6 cm, 1 compart. 6 x 13 cm

2 compart. 6 x 6 cm, 1 compart. 6 x 13 cm



	cm	↑ cm	€
14090	15 x 15	28	72,00

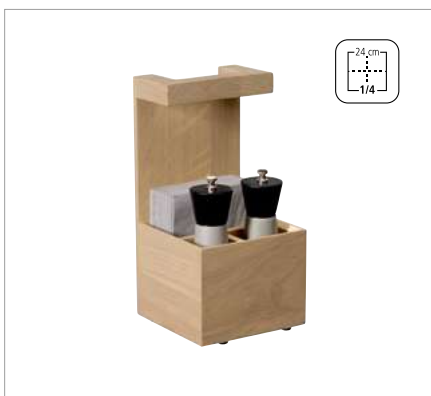

## Table Caddy „VALO“

table caddy  
caddy de mesa  
caddy de table

2 Fächer: 6 x 6 cm / 1 Fach: 6 x 13 cm

2 compartments: 6 x 6 cm / 1 compartment: 6 x 13 cm

2 compart. 6 x 6 cm, 1 compart. 6 x 13 cm

2 compart. 6 x 6 cm, 1 compart. 6 x 13 cm



	cm	↑ cm	€
14091	15 x 15	31	84,00

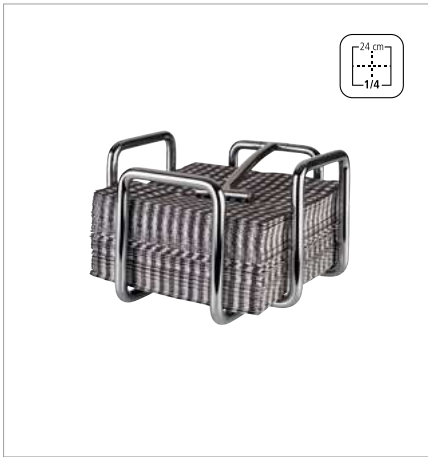

**Serviettenhalter „HERO“**

napkin holder  
servilletero  
porte-serviettes

für ca. 65 Cocktailservietten, inklusive Beschwerer

for approx. 65 cocktail napkins, including weight

para aprox. 65 servilletas cocktail, con barrita de contrapeso

pour environ 65 serviettes cocktail, avec barre de contrepoids



	cm	↑ cm	€
11767	14,5 x 14,5	10	11,00



inklusive Beschwerer  
including weight



**Serviettenhalter „URBAN“**

napkin holder  
servilletero  
porte-serviettes

für ca. 50 Servietten ¼ Falz, inklusive Beschwerer

for approx. 50 napkins ¼ fold, including weight

para aprox. 50 servilletas de plegado ¼, con barrita de contrapeso

pour environ 50 serviettes pliage ¼, avec barre de contrepoids



	cm	↑ cm	€
11770	19 x 19	7,5	11,60

für ca. 120 Servietten ¼ Falz, inklusive Beschwerer

for approx. 120 napkins ¼ fold, including weight

para aprox. 120 servilletas de plegado ¼, con barrita de contrapeso

pour environ 120 serviettes pliage ¼, incl. barrie de contrepoids

	cm	↑ cm	€
11771	19 x 19	18	15,40



inklusive Beschwerer  
including weight

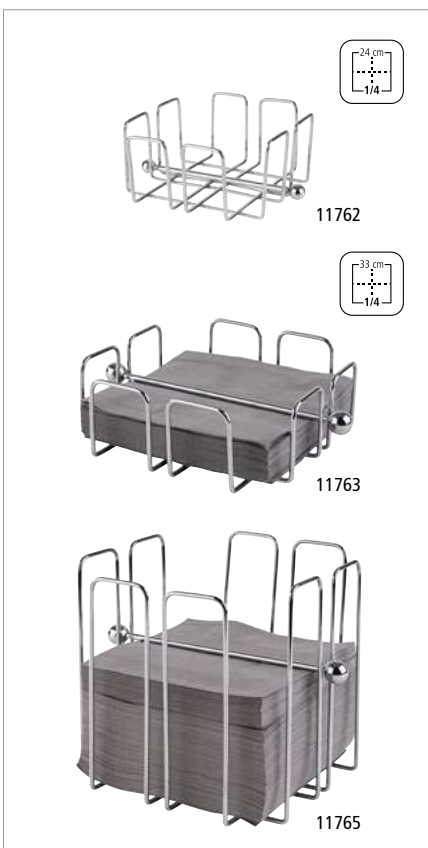

**Serviettenhalter „WIRE“**

napkin holder  
servilletero  
porte-serviettes

für ca. 50 Cocktailservietten, inklusive Beschwerer

for approx. 50 cocktail napkins, including weight

para aprox. 50 servilletas cocktail, con barrita de contrapeso

pour environ 50 serviettes cocktail, avec barre de contrepoids



	cm	↑ cm	€
11762	14 x 14	6,5	6,90

für 50 Servietten 1/4 Falz, inklusive Beschwerer

for 50 napkins 1/4 fold, including weight

para 50 servilletas plegado 1/4, con barrita de contrapeso

pour 50 serviettes pliage 1/4, avec barre de contrepoids

	cm	↑ cm	€
11763	19 x 19	6,5	7,20

für 150 Servietten 1/4 Falz, inklusive Beschwerer

for 150 napkins 1/4 fold, including weight

para 150 servilletas plegado 1/4, con barrita de contrapeso

pour 150 serviettes pliage 1/4, avec barre de contrepoids

	cm	↑ cm	€
11765	19 x 19	19,0	11,80



inklusive Beschwerer  
including weight

## NAPKIN HOLDERS



### Serviettenhalter „ELEMENT“

napkin holder  
servilletero  
porte-serviettes  
für ca. 50 Servietten  
for approx. 50 napkins  
para aprox. 50 servilletas  
pour environ 50 serviettes



	cm	↑ cm	€
11781	16 x 7,5	10	10,00



### Serviettenhalter

napkin holder  
servilletero  
porte-serviettes  
für ca. 30 Servietten, matt poliert  
for approx. 30 napkins, matt polished  
para aprox. 30 servilletas, pulido mate  
pour environ 30 serviettes, poli mat



	cm	↑ cm	€
11780	15 x 4,5	12,5	8,00



### Serviettenhalter

napkin holder  
servilletero  
porte-serviettes  
für ca. 20 Servietten, matt poliert  
for approx. 20 napkins, matt polished  
para aprox. 20 servilletas, pulido mate  
pour environ 20 serviettes, poli mat



	cm	↑ cm	€
11778	17 x 3	7	7,50



### Serviettenhalter

napkin holder  
servilletero  
porte-serviettes  
hochglanzpoliert  
mirror polished  
pulido brillante  
poli brillant



	cm	↑ cm	€
11720	10 x 11,5	18,5	12,40



**Besteckbehälter**  
cutlery box  
recipiente para cubiertos  
récipient pour couverts  
4 Fächer (26 x 11,5 cm)  
4 compartments (26 x 11,5 cm)  
4 compartimentos (26 x 11,5 cm)  
4 compartiments (26 x 11,5 cm)



	cm	↑ cm	Farbe / colour		€
11952	51 x 28	13		nature	58,00
11951	51 x 28	13		vintage white	58,00



**Besteckbehälter mit Deckel**  
cutlery box with cover  
caja de cubiertos con tapa  
range-couverts avec couvercle  
4 Fächer (26 x 11,5 cm), mit Deckel  
4 compartments (26 x 11,5 cm), with cover  
4 compartimentos (26 x 11,5 cm), con tapa  
4 compartiments (26 x 11,5 cm), avec couvercle



	cm	↑ cm	Farbe / colour		€
11949	51 x 28	14,5		nature	83,00
11948	51 x 28	14,5		vintage white	83,00

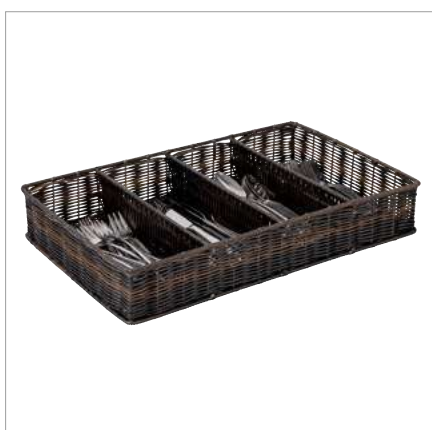

**GN 1/1 Besteckbehälter**  
GN 1/1 cutlery box  
GN 1/1 dispensador de cubiertos  
GN 1/1 bac à couverts  
4 Fächer (30,5 x 11,5 cm)  
4 compartments (30,5 x 11,5 cm)  
4 compartimentos (30,5 x 11,5 cm)  
4 compartiments (30,5 x 11,5 cm)



	cm	↑ cm	Farbe / colour	GN	€
11966	53 x 32,5	9		1/1	43,00



**GN 1/1 Besteckbehälter**  
GN 1/1 cutlery box  
GN 1/1 dispensador de cubiertos  
GN 1/1 bac à couverts  
4 Fächer (24,5 x 10,5 cm)  
4 compartments (24,5 x 10,5 cm)  
4 compartimentos (24,5 x 10,5 cm)  
4 compartiments (24,5 x 10,5 cm)



	cm	↑ cm	Farbe / colour	GN	€
11965	53 x 32,5	10		1/1	30,00

## CUTLERY BOXES



### Besteckbehälter

cutlery basket  
recipiente para cubiertos  
récipients pour couverts

4 Löcher inklusive 4 Edelstahl Köcher

4 holes including 4 stainless baskets

4 agujeros con 4 cestas de acero inoxidable

4 trous avec 4 corbeilles en acier inox



	cm	↑ cm	€
93321	27 x 27	15	84,00



### Besteckköcher

cutlery basket  
cesta para cubiertos  
corbeille à couverts

matt poliert / matt polished / pulido mate / poli mat



	Ø cm	↑ cm	€
11999	9,5	13,5	8,00



### Besteckbehälter / Korb „UTENSILO“

cutlery bin / basket  
porta cubiertos / cesta  
range-couverts / corbeille

Boden: 29 x 8,5 cm, mit Kunststoffeinsatz

base: 29 x 8,5 cm, with plastic insert

base: 29 x 8,5 cm, con inserto de plástico

fond: 29 x 8,5 cm, avec insert en plastique



	cm	↑ cm	ltr.	€
11754	29,5 x 12	10	2	12,00



mit Kunststoffeinsatz  
with plastic insert



Präsentationsmöglichkeit  
presentation example



### Besteckkasten „INDUSTRIAL“

cutlery box  
caja para cubiertos  
boîte pour couverts



	cm	↑ cm	ltr.	€
40676	23,0 x 15,5	13,0	2,4	15,20



**Deckel für Besteckbehälter**  
 lid for cutlery container  
 tapa para recipiente de cubiertos  
 couvercle pour bac à couverts



**passend für Besteckbehälter**  
 suitable for cutlery containers  
 para recipiente de cubiertos  
 pour bacs à couverts

	cm	↑ cm	fits to	€
11964	53 x 32,5	4	11954, 11955, 11960	6,30



11954



11955

**GN 1/1 Besteckbehälter**  
 GN 1/1 cutlery bin  
 GN 1/1 recipiente para cubiertos  
 GN 1/1 récipients pour couverts



**4 Fächer (25 x 10,5 cm)**  
 4 compartments (25 x 10,5 cm)  
 4 compartimentos (25 x 10,5 cm)  
 4 compartiments (25 x 10,5 cm)

	cm	↑ cm	Farbe / colour	GN	€
11954	53 x 32,5	10		1/1	7,50
11955	53 x 32,5	10		1/1	7,50



**GN 1/1 Besteckbehälter**  
 GN 1/1 cutlery bin  
 GN 1/1 recipiente para cubiertos  
 GN 1/1 récipients pour couverts



**3 Fächer (25 x 10,5 cm), 3 Köcher (Ø 7 cm)**  
 3 compartments (25 x 10,5 cm), 3 cutlery baskets (Ø 7 cm)  
 3 compartimentos (25 x 10,5 cm), 3 cestas para cubiertos (Ø 7 cm)  
 3 compartiments (25 x 10,5 cm), 3 corbeilles à couverts (Ø 7 cm)

	cm	↑ cm	GN	€
11960	53 x 32,5	10	1/1	7,50

# BUFFET STANDS



33249



33311



33251



33313

## Buffetständer „MULTI“

buffet stand  
soporte para buffet  
présentoir buffet



die Kombination verschiedener Höhen erzeugt eine ansprechende Tiefe auf dem Buffet  
the combination of different heights creates an appealing depth on the buffet  
la combinación de diferentes alturas crea una profundidad atractiva en el buffet  
la combinaison de différentes hauteurs crée une profondeur attrayante sur le buffet

	cm	↑ cm	Farbe / colour	€
33249	18 x 18	5	■ black	9,60
33250	18 x 18	8	■ black	13,20
33251	18 x 18	10	■ black	16,00
33252	18 x 18	20	■ black	18,90
33310 <small>NEW</small>	18 x 18	5	■ gold	10,80
33311 <small>NEW</small>	18 x 18	8	■ gold	14,20
33312 <small>NEW</small>	18 x 18	10	■ gold	17,00
33313 <small>NEW</small>	18 x 18	20	■ gold	20,00



mit Antirutschbeschichtung  
with anti-slide coating



**Buffetständer „MULTI“**

buffet stand  
soporte para buffet  
présentoir buffet

die Kombination verschiedener Höhen erzeugt eine ansprechende Tiefe auf dem Buffet  
the combination of different heights creates an appealing depth on the buffet  
la combinación de diferentes alturas crea una profundidad atractiva en el buffet  
la combinaison de différentes hauteurs crée une profondeur attrayante sur le buffet



	Ø cm	↑ cm	€
33269	15,5 / 18	8	10,90
33270	15,5 / 18	10	13,00
33271	15,5 / 18	18	16,70



mit Antirutschbeschichtung  
with anti-slide coating

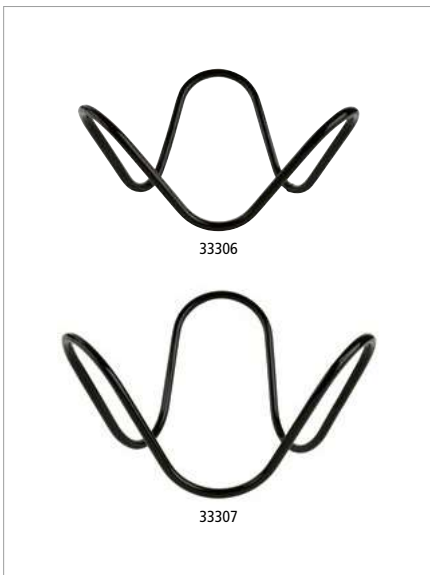

**Buffetständer „WAVE“**

buffet stand  
soporte para buffet  
présentoir buffet  
mit Antirutschbeschichtung

with non-slip coating  
con revestimiento antideslizante  
avec revêtement antidérapant



	Ø cm	↑ cm	€
33306	20	9,5	10,40
33307	24	13,0	12,50



Präsentationsmöglichkeit  
presentation example



**Buffetständer „PRISMA“**

buffet stand  
soporte para buffet  
présentoir buffet

Metall, mit schwarzer Antirutschbeschichtung  
metal, with black anti-slide coating  
metal, con revestimiento antideslizante negro  
métal, avec revêtement antidérapant noir



	Ø cm	↑ cm	€
33272	20	10,5	10,20
33273	20	20,0	14,50

## BUFFET STANDS



### Buffetständer „STAR“

buffet stand  
soporte para buffet  
présentoire buffet

**Metall, mit schwarzer Antirutschbeschichtung**

metal, with black anti-slide coating  
metal, con revestimiento antideslizante negro  
métal, avec revêtement antidérapant noir



	↑ cm	€
33260	8	14,80
33261	12	17,50
33262	18	20,00

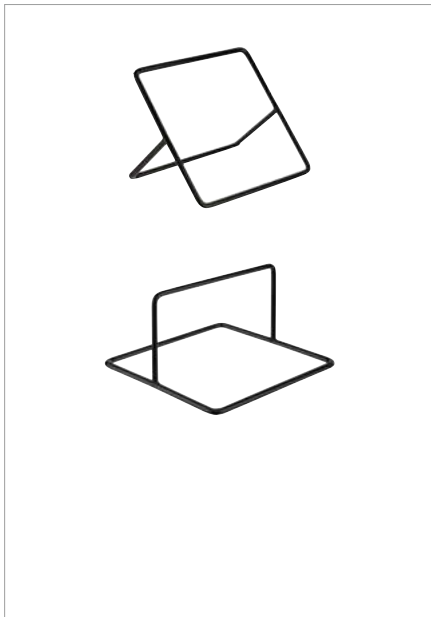

### Buffetständer „SQUARE“

buffet stand  
soporte para buffet  
présentoir buffet

**Metall, mit schwarzer Antirutschbeschichtung**

metal, with black anti-slide coating  
metal, con revestimiento antideslizante negro  
métal, avec revêtement antidérapant noir



	cm	↑ cm	€
33305	12 x 12	7	6,20



Präsentationsmöglichkeit  
presentation example



### Buffetständer „FRIDA“

buffet stand  
soporte para buffet  
présentoir buffet

**Metall, mit schwarzer Antirutschbeschichtung**

metal, with black anti-slide coating  
metal, con revestimiento antideslizante negro  
métal, avec revêtement antidérapant noir



	Ø cm	↑ cm	fits to	€
33282	23 / 30,5	16	85230, 85231	40,00

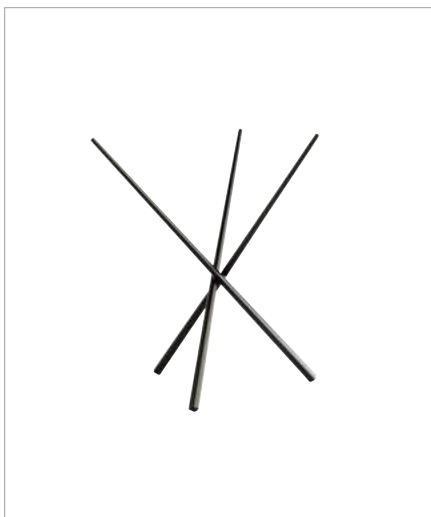

### Buffetständer „ASIA PLUS“

buffet stand  
soporte para buffet  
présentoir buffet



	Ø cm	↑ cm	€
15514	20,5 / 16,5	20	15,60



Präsentationsmöglichkeit  
presentation example



**Buffetständer „KING“**

buffet stand  
soporte para buffet  
présentoir buffet



kein Verrutschen, Arme und Boden sind mit Antirutschflächen ausgestattet, schwere standsichere Qualität, Fuß dient als Löffelablage

the arms and base are equipped with non-slip surfaces, stable quality, base serves as spoon holder

revestimiento antideslizante en las puntas de los brazos y en la base, estable y alta calidad, la base sirve como reposacuchara

revêtement antidérapant sur les extrémités des 3 pieds et sur la base, robuste, stable et bonne qualité, la base sert de support pour les couverts

	Ø cm	↑ cm	€
03622	15	14	44,00
03623	15	21	48,00



**Buffetständer „WOOD“**

buffet stand  
soporte para buffet  
présentoir buffet



Akazienholz, liegend oder stehend, variable Nutzungsmöglichkeiten

acacia wood, usable by lying or standing, variable usage possibilities

madera de acacia, se puede usar tumbado o de pie, opciones de uso variable

bois d'acacia, possibilités d'utilisation variables

	cm	↑ cm	Farbe / colour	€
33280	20 x 20	17,5		12,40
33281	20 x 20	17,5		12,40



liegend oder stehend, variable Nutzungsmöglichkeiten  
vertically or horizontally, variable usage possibilities



**Buffetständer**

buffet stand  
soporte para buffet  
présentoir buffet



Akazienholz

acacia wood

madera de acacia

bois d'acacia

	Ø cm	↑ cm	€
33255	15	10	18,00
33256	25	15	22,00



Präsentationsmöglichkeit  
presentation example

# MANGO



## Schale „MANGO“

bowl  
cuenco  
bol



handgefertigte Schale mit edler, innenliegender Epoxidharzbeschichtung

handmade bowl with a refined inner epoxy resin coating

cuenco hecho a mano con un elegante revestimiento interior de resina epoxi

bol fabriqué à la main avec un élégant revêtement intérieur en résine époxy

	Ø cm	↑ cm	ltr.	€
01050	20	7,5	0,8	21,00
01053	24	7,5	1,1	25,00
01056	30	10,5	3,0	35,00
01057	37	9,0	4,0	35,00



## Tablett / Teller „MANGO“

tray / plate  
bandeja / plato  
plateau / assiette



handgefertigter Teller mit edler, innenliegender Epoxidharzbeschichtung

handmade plate with a refined inner epoxy resin coating

plato hecho a mano con un elegante revestimiento interior de resina epoxi

assiette fabriquée à la main avec un élégant revêtement intérieur en résine époxy

	Ø cm	↑ cm	€
01058	35,5	2,5	32,00

NEW



01060



01062

## Schale „MANGO“

bowl  
cuenco  
bol

handgefertigte Schale mit edler, innenliegender Epoxidharzbeschichtung

handmade bowl with a refined inner epoxy resin coating

cuenco hecho a mano con un elegante revestimiento interior de resina epoxi

bol fabriqué à la main avec un élégant revêtement intérieur en résine époxy

	Ø cm	↑ cm	ltr.	€
01060	20	7,5	0,8	21,00
01062	30	10,5	3,0	35,00



## Schale „MANGO“

bowl  
cuenco  
bol

handgefertigte Schale mit edler, innenliegender Epoxidharzbeschichtung

handmade bowl with a refined inner epoxy resin coating

cuenco hecho a mano con un elegante revestimiento interior de resina epoxi

bol fabriqué à la main avec un élégant revêtement intérieur en résine époxy

	Ø cm	↑ cm	ltr.	€
01051	24	7,5	1,1	25,00
01054	30	10,5	3,0	35,00



01051



01054



# TERRAZZO



NEW



30080



30081



30082

## Schale „TERRAZZO“

bowl  
cuenco  
bol

Terrazooptik

terrazzo look

aspecto terrazo

optique terrazzo



	Ø cm	↑ cm	ltr.	€
30080	22,0	6,0 / 10,5	1,1	24,00
30081	26,0	7,5 / 13,0	1,7	31,00
30082	29,5	8,5 / 14,5	2,5	36,00

Farb- und Strukturabweichungen möglich  
colour and texture variations possible

NEW

**Dose, 2er Set „TERRAZZO“**

container, 2 pcs.  
recipiente, set de 2  
boîte, set de 2



**ideal zum Servieren von Aufstrichen, Butter, Gewürzen oder kleinen Delikatessen**

ideal for serving spreads, butter, spices, or small delicacies

ideal para servir untables, mantequilla, especias o pequeñas delicias

idéel pour servir des tartinades, du beurre, des épices ou de petites gourmandises

	Ø cm	↑ cm	ml	pcs.	€ / set
15917	6	5	40	2	15,00

Farb- und Strukturabweichungen möglich  
colour and texture variations possible

**Flaschenkühler „TERRAZZO“**

bottle cooler  
enfriador de botella  
rafraîchisseur de bouteille



**Terrazooptik**

terrazzo look

aspecto terrazo

optique terrazzo

	Ø cm	↑ cm	€
36150	12,5 / 10	19	20,00

Farb- und Strukturabweichungen möglich  
colour and texture variations possible

**Besteckbehälter „TERRAZZO“**

cutlery bin  
recipiente para cubiertos  
récipients pour couverts



**Terrazooptik, mit Abflussloch, Bodeneinlage aus Silikon zum Schonen des Bestecks**

terrazzo look, with drain hole, silicone bottom insert for protecting the points of knives

aspecto terrazo, con orificio de drenaje, soporte de silicona para proteger las puntas de los cuchillos

optique terrazzo, avec le trou de drainage, insert de silicone pour protéger les pointes des couteaux

	Ø cm	↑ cm	€
11760	11	13,5	17,00

Farb- und Strukturabweichungen möglich  
colour and texture variations possible



# ELEMENT



## Schale „ELEMENT“ bowl cuenco bol



	∅ cm	↑ cm	ltr.	€
30000	22,0	6,0 / 10,5	1,1	22,00
30001	26,0	7,5 / 13,0	1,7	28,00
30002	29,5	8,5 / 14,5	2,5	33,00



möbelschonende Unterseite  
furniture-friendly underside



## Serviettenhalter „ELEMENT“

napkin holder  
servilletero  
porte-serviettes  
für ca. 50 Servietten  
for approx. 50 napkins  
para aprox. 50 servilletas  
pour environ 50 serviettes



	cm	↑ cm	€
11781	16 x 7,5	10	10,00

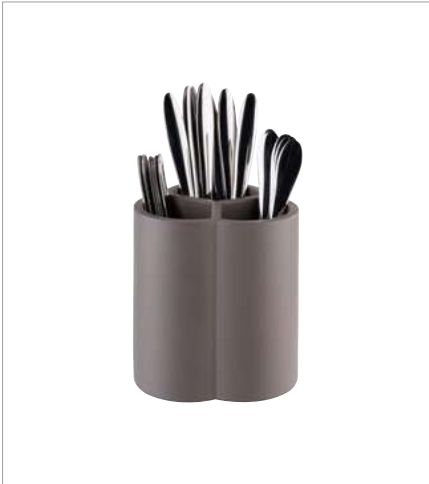

**Besteckbehälter „ELEMENT“**

cutlery bin  
porta cubiertos  
range-couverts



**3 Fächer, Silikoneinlage zum Schonen des Bestecks**

3 compartments, silicone inlay to protect the cutlery

3 compartimentos, inserto de silicona para proteger cubiertos

3 compartiments, insert en silicone pour ménager les couverts

	cm	↑ cm	€
11750	13 x 13	14,5	18,00



**Besteckbehälter „ELEMENT“**

cutlery bin  
recipiente para cubiertos  
récipients pour couverts



**mit Abflussloch, Bodeneinlagen aus Silikon zum Schonen des Bestecks**

with drain hole, silicone bottom inserts for protecting the points of knives

con orificio de drenaje, soporte de silicona para proteger las puntas de los cuchillos

avec le trou de drainage, insert de silicone pour protéger les pointes des couteaux

	Ø cm	↑ cm	€
00018	11	14	17,00



**Flaschenkühler „ELEMENT“**

bottle cooler  
enfriador de botella  
rafraîchisseur de bouteille



	Ø cm	↑ cm	€
36131	12 / 10	19	20,00



**Flaschenkühler „ELEMENT“**

bottle cooler  
enfriador de botella  
rafraîchisseur de bouteille



	Ø cm	↑ cm	€
36090	12 / 10	19	20,00

# CEREAL DISPENSERS



## Cerealienspender „FRESH & EASY“

cereal dispenser  
dispensador de cereales  
distributeur de céréales

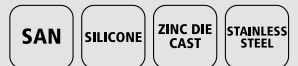

**Behälter herausnehmbar, „Feierabend-Deckel“ für das aromadichte Lagern, Portionieren durch einfaches Drehen**

removable canister, special lid to keep the cereals fresh, easy to use, rotate the button to get the muesli

contenedor extraíble, tapa especial para mantener los cereales frescos, fácil de usar, se gira el pomo para servir los cereales

réceptacle amovible, couvercle spécial pour conserver les céréales, usage facile en tournant le bouton

	cm	↑ cm	ltr.	€
11840	22 x 17,5	52	4,5	90,00



## Cerealienspender Duo „FRESH & EASY“

cereal dispenser  
dispensador de cereales  
distributeur de céréales

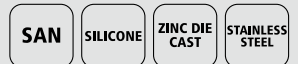

**Behälter herausnehmbar, „Feierabend-Deckel“ für das aromadichte Lagern, Portionieren durch einfaches Drehen**

removable canister, special lid to keep the cereals fresh, easy to use, rotate the button to get the muesli

contenedor extraíble, tapa especial para mantener los cereales frescos, fácil de usar, se gira el pomo para servir los cereales

réceptacle amovible, couvercle spécial pour conserver les céréales, usage facile en tournant le bouton

	cm	↑ cm	ltr.	€
11841	22 x 35	52	2 x 4,5	162,00

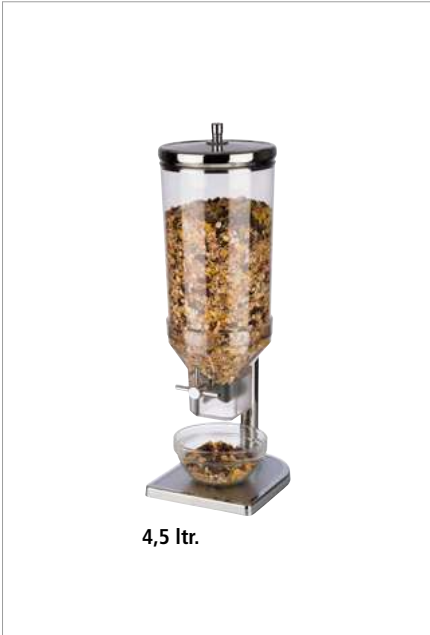

4,5 ltr.

**Cerealienspender „FRESH & EASY“**

cereal dispenser  
dispensador de cereales  
distributeur de céréales

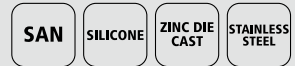

Behälter herausnehmbar, „Feierabend-Deckel“ für das aromadichte Lagern,  
Portionieren durch einfaches Drehen

removable canister, special lid to keep the cereals fresh, easy to use, rotate the button to get the muesli  
contenedor extraíble, tapa especial para mantener los cereales frescos, fácil de usar, se gira el pomo para servir los cereales  
récipient amovible, couvercle spécial pour conserver les céréales, usage facile en tournant le bouton

	cm	↑ cm	ltr.	€
11805	22 x 17,5	52	4,5	90,00



2 x 4,5 ltr.

**Cerealienspender Duo „FRESH & EASY“**

cereal dispenser  
dispensador de cereales  
distributeur de céréales



Behälter herausnehmbar, „Feierabend-Deckel“ für das aromadichte Lagern,  
Portionieren durch einfaches Drehen

removable canister, special lid to keep the cereals fresh, easy to use, rotate the button to get the muesli  
contenedor extraíble, tapa especial para mantener los cereales frescos, fácil de usar, se gira el pomo para servir los cereales  
récipient amovible, couvercle spécial pour conserver les céréales, usage facile en tournant le bouton

	cm	↑ cm	ltr.	€
11807	22 x 35	52	2 x 4,5	162,00



3 x 4,5 ltr.

**Cerealienspender „ROTATION“**

cereal dispenser  
dispensador de cereales  
distributeur de céréales



matt poliert, drehbarer massiver Ständer, Behälter herausnehmbar, inklusive Frischhaltedeckel  
matt polished, rotating food, canister removable, including airtight covers

pulido mate, giratorio, incluye tapas herméticas  
poli mat, rotatif, inclut couvercles hermétiques

	Ø cm	↑ cm	ltr.	€
11970	38	54	3 x 4,5	320,00

## CEREAL DISPENSERS



### Cerealienspender „BRIDGE“

cereal dispenser  
dispensador de cereales  
distributeur de céréales



Behälter herausnehmbar, „Feierabend-Deckel“ für das aromadichte Lagern, Portionieren durch einfaches Drehen

removable canister, special lid to keep the cereals fresh, easy to use, rotate the button to get the muesli  
contenedor extraíble, tapa especial para mantener los cereales frescos, fácil de usar, se gira el pomo para servir los cereales  
récipient amovible, couvercle spécial pour conserver les céréales, usage facile en tournant le bouton

	cm	↑ cm	ltr.	Farbe / colour		€
13987	21 x 20	55,5	4,5		Ahorn / maple	114,00



### Cerealienspender „BRIDGE“

cereal dispenser  
dispensador de cereales  
distributeur de céréales



Behälter herausnehmbar, „Feierabend-Deckel“ für das aromadichte Lagern, Portionieren durch einfaches Drehen

removable canister, special lid to keep the cereals fresh, easy to use, rotate the button to get the muesli  
contenedor extraíble, tapa especial para mantener los cereales frescos, fácil de usar, se gira el pomo para servir los cereales  
récipient amovible, couvercle spécial pour conserver les céréales, usage facile en tournant le bouton

	cm	↑ cm	ltr.	Farbe / colour		€
14987	21 x 20	55,5	4,5		Buche / beech	114,00



### Buffetständer „GOOD MORNING“

buffet stand  
soporte para buffet  
présentoir buffet



4-teiliges Set: 1 Holzständer inklusive 3 Gläser mit luftdichtem Klappdeckel

4 pcs.: 1 wood stand including 3 glasses with airtight cover

set de 4: 1 soporte con 3 cuencos de cristal con cierre hermético

set de 4: 1 présentoir avec 3 bols en verre avec fermeture hermétique

	cm	Farbe / colour	Holz / Wood	€
13965	43 x 17		Ahorn / maple	112,00
14965	43 x 17		Buche / beech	112,00

### Glas mit luftdichtem Klappdeckel

glass with airtight cover  
cristal, cierre hermético  
verre, fermeture hermétique

	cm	↑ cm	ltr.	€
82328	12 x 12	22	2	9,00



5 tlg.  
5 pcs.

**Cerealien-Bar**

cereal-bar  
barra para dispensador de cereales  
bar à céréales



**5-teiliges Set: mit Ständerhöhe 4 cm: 1 Ständer aus Acryl gefrostet und rutschfest + 2 Karaffen mit schwenkbarem Edelstahl-Deckel + 2 luftdichte Frischhaltedeckel**  
5 pcs.: with stand heights 4 cm: 1 stand acryl frosted and non-slip + 2 pitchers with stainless steel flap lid + 2 airtight covers  
set de 5: stands a diferentes alturas, 4 cm: 1 stand acryl + 2 jarras con tapa de solapa de acero inoxidable + 2 tapas herméticas adicionales  
set de 5: supports à différentes hauteurs: 4 cm - 1 support acrylique satiné antidérapant + 2 pichets à céréales avec couvercle à charnière inox + 2 couvercles hermétiques

	cm	↑ cm	ltr.	€
11971	26 x 17	28,5	2 x 1,5	76,00



7 tlg.  
7 pcs.

**Cerealien-Bar**

cereal-bar  
barra para dispensador de cereales  
bar à céréales



**7-teiliges Set: mit Ständerhöhe 4 cm: 1 Ständer aus Acryl gefrostet und rutschfest + 3 Karaffen mit schwenkbarem Edelstahl-Deckel + 3 luftdichte Frischhaltedeckel**  
7 pcs.: with stand heights 4 cm: 1 stand acryl frosted and non-slip + 3 pitchers with stainless steel flap lid + 3 airtight covers  
set de 7: con stands a diferentes alturas, 4 cm: 1 stand acryl + 3 jarras con tapa de solapa de acero inoxidable + 3 tapas herméticas adicionales  
set de 7: supports à différentes hauteurs: 4 cm - 1 support acrylique satiné antidérapant + 3 pichets à céréales avec couvercle à charnière inox + 3 couvercles hermétiques

	cm	↑ cm	ltr.	€
11973	38 x 17	28,5	3 x 1,5	108,00



**Cerealienkaraffe**

cereal pitcher  
jarra de cereales  
pichet à céréales



**schwenkbarer Edelstahldeckel, inklusive luftdichtem Frischhaltedeckel**  
stainless steel flap lid, inclusive airtight cover  
tapa giratoria de acero inoxidable con tapa hermética para mantener los alimentos frescos  
couvercle pivotant en acier inox avec couvercle hermétique pour conserver les aliments

	Ø cm	↑ cm	ltr.	€
10778	10	28	1,5	27,00

**Frischhaltedeckel / conservation lid / tapa de conservación / couvercle de conservation**

10668				3,00
-------	--	--	--	------

# BUFFET LADDER GN



## Buffetleiter „LITTLE GN 1/3“

buffet ladder  
dispensador en escalera  
présentoir buffet en escalier

4-teilig: 1 Leiter-Gestell, 3 GN 1/3 Rahmen

4 pcs.: 1 ladder, 3 single rings GN 1/3

set de 4: 1 soporte escalera, 3 aros sencillos GN 1/3

set de 4: 1 support escalier, 3 cercles simples GN 1/3

METAL  
CHROME  
PLATED

	cm	↑ cm	fits to	€
11526	31,5 x 32	48	baskets / pans GN 1/3	78,00



## Buffetleiter „LITTLE GN 1/2“

buffet ladder  
dispensador en escalera  
présentoir buffet en escalier

4-teilig: 1 Leiter-Gestell, 3 GN 1/2 Rahmen

4 pcs.: 1 ladder, 3 single rings GN 1/2

set de 4: 1 soporte escalera, 3 aros sencillos GN 1/2

set de 4: 1 support escalier, 3 cercles simples GN 1/2

METAL  
CHROME  
PLATED

	cm	↑ cm	fits to	€
11527	31,5 x 41,5	48	baskets / pans GN 1/2	98,00

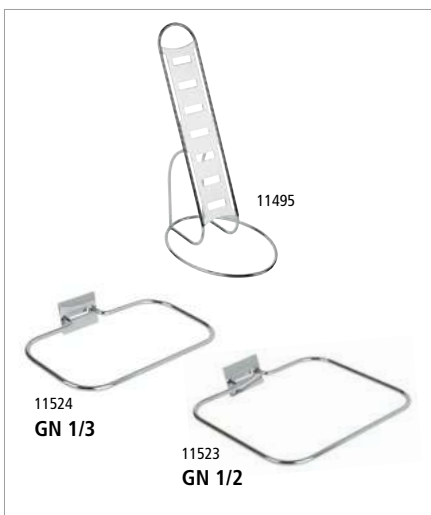

Einzelteile / spare parts / piezas sueltas / pièces détachées

Leitergestell / frame / marco de escalera / échelle support

11495	40,00
-------	-------

Einzelring GN 1/3 / single ring GN 1/3 / aro sencillo GN 1/3 / cercle simple GN 1/3

11524	14,80
-------	-------

Einzelring GN 1/2 / single ring GN 1/2 / aro sencillo GN 1/2 / cercle simple GN 1/2

11523	20,00
-------	-------



2x 40290  
GN 1/2

40291  
GN 1/1

40291  
GN 1/1

11529

3x 83753  
GN 1/3

2x 83757  
GN 1/2

1x 83759  
GN 1/1



3x 83753  
GN 1/3

4 tlg.  
4 pcs.

2x 83757  
GN 1/2

1x 83759  
GN 1/1

**Buffetleiter „BIG GN 1/1“**

buffet ladder  
dispensador en escalera  
présentoir buffet en escalier

4-teilig: 1 Leiter-Gestell, 3 GN 1/1 Rahmen

4 pcs.: 1 ladder, 3 single rings GN 1/1

set de 4: 1 soporte escalera, 3 aros sencillos GN 1/1

set de 4: 1 support escalier, 3 cercles simples GN 1/1

METAL  
CHROME  
PLATED

	cm	↑ cm	fits to	€
11529	52 x 59	66	baskets / pans GN 1/1	160,00

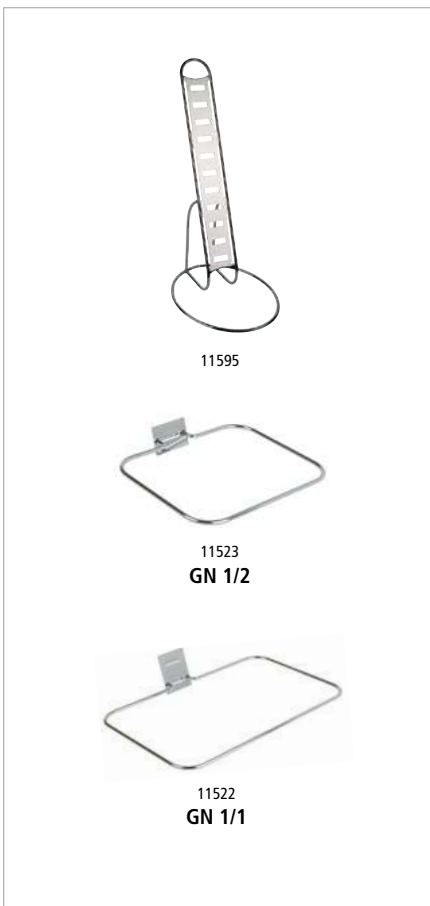

11595

11523  
GN 1/2

11522  
GN 1/1

Einzelteile / spare parts / piezas sueltas / pièces détachées

Leitergestell / frame / marco de escalera / échelle support

11595	€
11595	110,00

Einzelring GN 1/2 / single ring GN 1/2 / aro sencillo GN 1/2 / cercle simple GN 1/2

11523	€
11523	20,00

Einzelring GN 1/1 / single ring GN 1/1 / aro sencillo GN 1/1 / cercle simple GN 1/1

11522	€
11522	31,00

## BUFFET LADDERS



### Buffetleiter „BIG“

buffet ladder  
dispensador en escalera  
présentoir buffet en escalier



12-teiliges Set: 4 Glasschalen Ø 23 cm 2,5 Liter, 4 klappbare Schutzdeckel mit Beschriftungsfenster, 1 Leiter, 1 Doppelring, 2 Einzelringe, einfach und individuell zusammensetzbar

12 pcs. set: 4 glass bowls Ø 23 cm 2.5 litres, 4 hinged covers with card for inscription, 1 ladder, 1 double ring, 2 single rings, easy to fix and individual to use  
set de 12: 4 cuencos de vidrio Ø 23 cm 2,5 l, 4 tapas abatibles con ventana para etiqueta, 1 soporte escalera, 1 aro doble, 2 aros sencillos, fácil de montar, posible usar individualmente  
set de 12: 4 bols en verre Ø 23 cm 2,5 l, 4 couvercles à charnière et fenêtre pour étiquette, 1 support escalier, 1 cercle double, 2 cercles simples, montage facile, utilisable individuellement

	cm	↑ cm	€
11598	39 x 31	66	210,00



### Buffetleiter „BIG“

buffet ladder  
dispensador en escalera  
présentoir buffet en escalier



11-teiliges Set: 6 Glasschalen Ø 23 cm 2,5 Liter, 1 Leiter, 2 Doppelringe, 2 Einzelringe, einfach und individuell zusammensetzbar

11 pcs. set: 6 glass bowls Ø 23 cm 2.5 litres, 1 ladder, 2 double rings, 2 single rings, easy and individual to use  
set de 11: 6 cuencos de vidrio Ø 23 cm 2,5 l, 1 soporte escalera, 2 aros dobles, 2 aros sencillos, fácil montar, se puede usar individualmente  
set de 11: 6 bols en verre Ø 23 cm 2,5 l, 1 support escalier, 2 cercles doubles, 2 cercles simples, montage facile, utilisable individuellement

	cm	↑ cm	€
11599	39 x 31	66	190,00

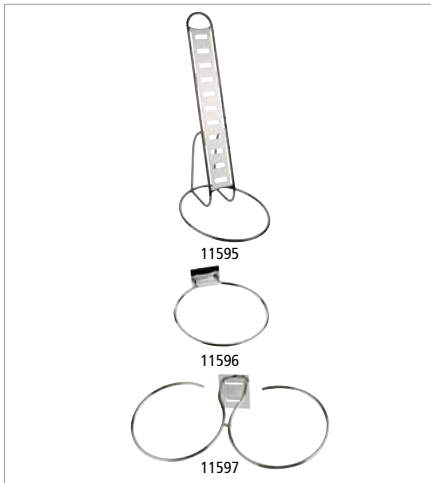

Einzelteile / spare parts / piezas de recambio / pièces détachées

Leitergestell / frame / marco solo / échelle support

	cm	↑ cm	€
11595	39 x 31	66	110,00

Einzelring / single ring / aro sencillo / cercle simple

	Ø cm	€
11596	23,5	15,00

Doppelring / double ring / aro doble / cercle double

	cm	€
11597	48 x 23,5	28,00



### Schale

bowl  
cuenco  
bol



	Ø cm	↑ cm	ltr.	VE / unit	€ / pc.
11875	23,0	10,5	2,50	6	7,00



### Schutzdeckel mit Löffelaussparung

cover  
tapa  
couvercle



	Ø cm	fits to	€
11878	23,5	11875	12,60



**Buffeteleiter „LITTLE“**

buffet ladder  
dispensador en escalera  
présentoir buffet en escalier



**12-teiliges Set: 4 Glasschalen Ø 14 cm 0,5 Liter, 4 klappbare Schutzdeckel mit Beschriftungsfenster, 1 Leiter, 1 Doppelring, 2 Einzelringe, einfach und individuell zusammensetzbar**

12 pcs. set: 4 glass bowls Ø 14 cm 0.5 litres, 4 hinged covers with card for inscription, 1 ladder, 1 double ring, 2 single rings, easy and individual to use  
set de 12: 4 cuencos de vidrio Ø 14 cm 0,5 l, 4 tapas abatibles con ventana para etiqueta, 1 soporte escalera, 1 aro doble, 2 aros sencillos, fácil montaje, se puede usar individualmente  
set de 12: 4 bols en verre Ø 14 cm 0,5 l, 4 couvercles à charnière et fenêtre pour étiquette, 1 support escalier, 1 cercle double, 2 cercles simples, montage facile, utilisable individuellement

	cm	↑ cm	€
11498	30 x 30	48	130,00



**Buffeteleiter „LITTLE“**

buffet ladder  
dispensador en escalera  
présentoir buffet en escalier



**11-teiliges Set: 6 Glasschalen Ø 14 cm 0,5 Liter, 1 Leiter, 2 Doppelringe, 2 Einzelringe, einfach und individuell zusammensetzbar**

11 pcs. set: 6 glass bowls Ø 14 cm 0.5 litres, 1 ladder, 2 double rings, 2 single rings, easy and individual to use  
set de 11: 6 cuencos de vidrio Ø 14 cm 0,5 l, 1 soporte escalera, 2 aros dobles, 2 aros sencillos, fácil montaje, se puede usar individualmente  
set de 11: 6 bols en verre Ø 14 cm 0,5 l, 1 support escalier, 1 cercles doubles, 2 cercles simples, montage facile, utilisable individuellement

	cm	↑ cm	€
11499	30 x 30	48	110,00

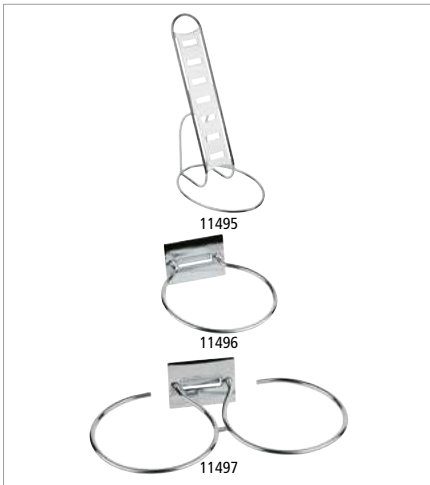

Einzelteile / spare parts / piezas de recambio / pièces détachées

**Leitergestell / frame / marco solo / échelle support**

	Ø cm	↑ cm	€
11495	30	48	40,00

**Einzelring / single ring / aro sencillo / cercle simple**

	Ø cm	€
11496	14	10,80

**Doppelring / double ring / aro sencillo / cercle double**

	cm	cm	€
11497	29,5 x 14,5	48	19,00



**Schale**  
bowl  
cuenco  
bol



	Ø cm	↑ cm	ltr.	VE / unit	€ / pc.
11865	14	6,5	0,5	6	3,00



**Schutzdeckel mit Löffelaussparung**

cover  
tapa  
couvercle



	Ø cm	fits to	€
11868	14,5	11865	12,00

## BUFFET DISPLAYS



### Buffetgestell „SUNDAY“

buffet stand  
expositor buffet  
présentoir buffet



7-teiliges Set: 3 Glasschalen Ø 23 cm (2,5 Liter), 3 klappbare Schutzdeckel, 1 Gestell

7 pcs. set: 3 glass bowls Ø 23 cm (2,5 litres), 3 hinged covers, 1 stand

set de 7: 3 cuencos de cristal Ø 23 cm (2,5 litro), 3 tapas con bisagra, 1 soporte

set de 7: 3 bols en verre Ø 23 cm (2,5 litre), 3 couvercles à charnière, 1 support

	cm	↑ cm	€
11795	61 x 24	35	136,00



### Serviergestell

servicing stand  
expositor  
présentoir



ohne Gläser, 12 x Ø 6 cm

without glasses, 12 x Ø 6 cm

sin vasos, 12 x Ø 6 cm

sans verrines, 12 x Ø 6 cm

	Ø cm	↑ cm	€
33246	22	59	12 x Ø 6 cm 94,00

passende Gläser / matching glasses / tarros adecuados / verrines appropriées

	Ø cm	↑ cm	ltr.	pcs	€/ set
82310	6	5,5	0,08	12	22,70
82312	6	7,0	0,14	12	24,80
82314	6	8,0	0,16	12	24,80
82370	6	5,5	0,08	12	13,80
82371	6	8,0	0,16	12	14,80



### Schälchenspender „MINI“

bowl holder  
rack dispensador para cuencos  
porte-bols



Schälchenspender „MINI“ / bowl holder / rack dispensador para cuencos / porte-bols

	Ø cm	↑ cm	€
11980	14	25,5	Ständer ohne Schalen / frame without bowls 49,00 soporte sin cuencos / support sans bols

### Schälchen „CASUAL MINI“

bowl  
cuenco  
bol mini



	cm	↑ cm	ltr.	Farbe / colour	VE / unit	€/ pc.
83880	6,0	2,5	0,02		24	2,10

### Schale

bowl  
cuenco  
bol



	Ø cm	↑ cm	ltr.	VE / unit	€/ pc.
11859	6,0	2,5	0,05	6	2,00



93286 with decorative surface

93291 with decorative surface

Dosierspender „DISPENSA“

dosing dispenser  
dosificador  
distributeur de dosage

Behälter aus Glas, ideal zum Dosieren von Marmelade, Joghurt und Saucen (ohne Stücke / Fruchtfleisch)  
glass container, ideal for dosing jam, yoghurt and sauces (without pieces / pulp)  
recipiente de cristal, ideal para dosificar mermelada, yogur y salsas (sin trozos / pulpa)  
récipient en verre, idéal pour doser la confiture, le yaourt et les sauces (sans morceaux / pulpe)



	Ø cm	↑ cm	ltr.	€
93286	10	27	1,0	20,00
93291	13	27	1,7	26,00



Hubvolumen 15 ml  
stroke volume 15 ml



93285

93290

Dosierspender „DISPENSA“

dosing dispenser  
dosificador  
distributeur de dosage

Behälter aus Glas, ideal zum Dosieren von Marmelade, Joghurt und Saucen (ohne Stücke / Fruchtfleisch)  
glass container, ideal for dosing jam, yoghurt and sauces (without pieces / pulp)  
recipiente de cristal, ideal para dosificar mermelada, yogur y salsas (sin trozos / pulpa)  
récipient en verre, idéal pour doser la confiture, le yaourt et les sauces (sans morceaux / pulpe)



	Ø cm	↑ cm	ltr.	€
93285 <span style="color:red">NEW</span>	10	27	1,0	19,00
93290	13	27	1,7	24,00



Hubvolumen 15 ml  
stroke volume 15 ml



# BEVERAGE DISPENSERS

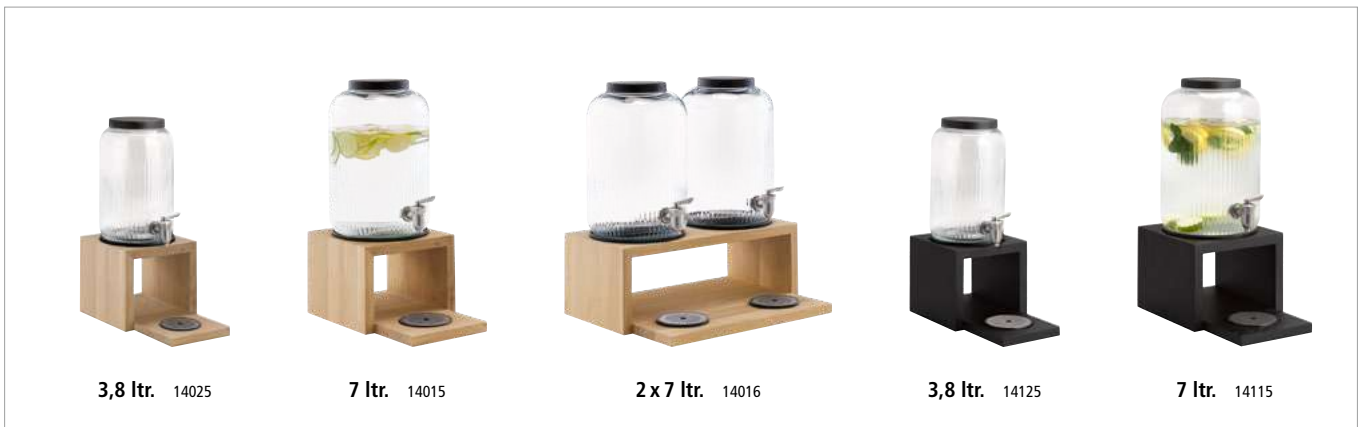

## Getränkespender „VALO“

beverage dispenser  
dispensador de bebidas  
distributeur de boissons

Podest wasserfest lackiert, Zapfhahn aus Edelstahl,  
Untersetzer aus Melamin, Bodenplatte (Gläserntablett) herausnehmbar

platform waterproof lacquered, stainless steel tap,  
melamine coaster, removeable base plate

podio con barniz impermeable, grifo de acero inoxidable,  
posavasos de melamina, placa base extraíble

podium verni imperméable, robinet en acier inox,  
dessous de verre en mélamine, plaque de fond amovible



	cm	↑ cm	ltr.	Farbe / colour	€
14025	18,0 x 18,0	41,0	3,8		200,00
14015	21,0 x 21,0	46,5	7,0		240,00
14016	43,5 x 21,0	46,5	2x 7,0		390,00
14125 <b>NEW</b>	18,0 x 18,0	41,0	3,8		220,00
14115 <b>NEW</b>	21,0 x 21,0	46,5	7,0		260,00



**Eiswasserröhre**  
ice cube cooling tube  
tubo enfriador para cubitos  
tube pour glaçons



	Ø cm	↑ cm	fits to	€
10849	11	23	14015, 14016, 14025, 14115, 14125	9,40



**Glaskaraffe**  
glass carafe  
jarra de vidrio  
carafe en verre



ideal für Cerealien, Säfte oder Milch, Deckel aus Kork  
ideal for cereals, juices or milk, cork lid  
ideal para cereales, zumos o leche, tapa de corcho  
idéal pour les céréales, les jus de fruits ou le lait, couvercle en liège

	Ø cm	↑ cm	ltr.	fits to	€
10725	9	19,5	0,5	14023, 14070, 14075, 14077, 14123, 14170	15,00
10726	9	27,5	1,0	14023, 14070, 14075, 14077, 14123, 14170	21,00
10727	9	35,0	1,5	14023, 14070, 14075, 14077, 14123, 14170	22,00

10725  
0,5 ltr.

10726  
1,0 ltr.

10727  
1,5 ltr.



## BEVERAGE DISPENSERS



7 ltr.

10460

7 ltr.

10400



7 ltr.

### Getränkespender „ELEMENT“

beverage dispenser  
dispensador de bebidas  
distributeur de boissons

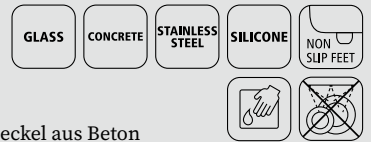

Behälter aus Glas, Zapfhahn aus Edelstahl, Fuß und Deckel aus Beton

glass container, stainless steel tap, stand and lid made of concrete

recipiente de vidrio, grifo de acero inoxidable, soporte y tapa de hormigón

réipient en verre, robinet en acier inox, support et couvercle en béton

	Ø cm	↑ cm	Farbe / colour	ltr.		€
10460	22	45	black	7	inkl. Standfuß / incl. stand	130,00
10400	22	45	concrete	7	inkl. Standfuß / incl. stand	130,00



10849

Eiswasserröhre separat erhältlich  
ice cube cooling tube available separately

### Getränkespender „ASIA“

beverage dispenser  
dispensador de bebidas  
distributeur de boissons



Behälter aus Glas, Zapfhahn aus Edelstahl, Fuß und Deckel aus Holz

glass container, stainless steel tap, wooden stand and lid

recipiente de vidrio, grifo de acero inoxidable, soporte y tapa de madera

réipient en verre, robinet en acier inox, support et couvercle en bois

	Ø cm	↑ cm	ltr.		€
10403	24,5	45,5	7	inkl. Gestell / incl. stand	98,00

Ersatz-Fuß / base / soporte de recambio / support de remplacement

	Ø cm	↑ cm	€
10404	24,5	15	26,00

Ersatz-Deckel / replacement lid / tapa de recambio / couvercle de rechange

	Ø cm	↑ cm	€
10405	14,0	5	10,40



**Getränkespender „INDUSTRIAL“**

beverage dispenser  
dispensador de bebidas  
distributeur de boissons

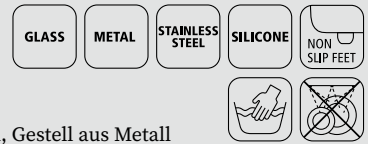

**Behälter aus Glas, Deckel und Zapfhahn aus Edelstahl, Gestell aus Metall**

glass container, stainless steel lid and tap, metal frame

recipiente de vidrio, tapa y grifo de acero inoxidable, soporte metálico

réipient en verre, couvercle et robinet en acier inox, support en métal

3,8 ltr.

10452

7 ltr.

10450

	Ø cm	↑ cm	ltr.		€
10452	16	40	3,8	inkl. Gestell / incl. stand	86,00
10450	20	45	7	inkl. Gestell / incl. stand	110,00



**Eiswasserröhre separat erhältlich**  
ice cube cooling tube available separately



**Getränkespender „URBAN“**

beverage dispenser  
dispensador de bebidas  
distributeur de boissons



**Behälter aus Glas, Deckel und Zapfhahn aus Edelstahl, Gestell aus Metall**

glass container, stainless steel lid and tap, metal frame

recipiente de vidrio, tapa y grifo de acero inoxidable, soporte metálico

réipient en verre, couvercle et robinet en acier inox, support en métal

7 ltr.

	Ø cm	↑ cm	ltr.		€
10451	22	45	7	inkl. Gestell / incl. stand	110,00



**Antirutschmatte aus Silikon**  
silicone anti-slip mat



Getränkespender

beverage dispenser  
dispensador de bebidas  
distributeur de boissons



Behälter aus Glas, Zapfhahn aus Edelstahl, Deckel aus Edelstahl

glass container, stainless steel tap, lid in stainless steel

recipiente de vidrio, grifo de acero inoxidable, tapa de acero inoxidable

réipient en verre, robinet en acier inox, couvercle en acier inox

	Ø cm	↑ cm	ltr.	€
10818	16	25,0	3,8	49,00
10819 <b>NEW</b>	20	23,0	5,0	59,00
10855	20	30,5	7,0	76,00

Ersatz-Zapfhahn / replacement tap

10718	€
	26,00



Eiswasserröhre separat erhältlich  
ice cube cooling tube available separately



**Untersetzer**

saucer  
plattillo  
sous-assiette



**Untersetzer für Getränkespender, schützt den Untergrund vor Wasserrändern**

saucer for beverage dispensers, protects the surface from water marks

plattillo para dispensadores de bebidas, protege la superficie las marcas de agua contra

sous-assiette pour distributeurs de boissons, protège le support contre les traces d'eau

	Ø cm	↑ cm	fits to	€
85233	16	1	10818	7,00
85232	19	1	10855, 10819	8,40



**Tropfenschale, 2-teilig**

drip tray, 2 pcs.  
aros anti-goteo, set de 2  
anneaux coupe-gouttes, set de 2



	Ø cm	↑ cm	Farbe / colour	€
10851	9,5	1,5	white	8,00
10841	9,5	1,5	black	8,00



**Eiswasserröhre**

ice cube cooling tube  
tubo enfriador para cubitos  
tube pour glaçons



	Ø cm	↑ cm	fits to beverage dispensers	€
10849	11	23	10400, 10403, 10450, 10451, 10452, 10460, 10818, 10855, 14015, 14016, 14025, 14115, 14125	9,40



## BEVERAGE DISPENSERS



10,5 ltr.

### Getränkespender „FRUITS“

beverage dispenser  
dispensador de bebidas  
distributeur de boissons



Behälter aus Glas, Zapfhahn aus Edelstahl, Gestell schwarz

glass container, stainless steel tap, black stand

recipiente de vidrio, grifo de acero inoxidable, soporte negro

réceptien en verre, robinet en acier inox, support noir

	Ø cm	↑ cm	ltr.		€
10415	25	58	10,5	inkl. Gestell / incl. stand	98,00

Ersatz-Glas inklusive Deckel, ohne Zapfhahn / replacement glass with lid without tap / cristal de recambio con tapa sin grifo / vitre de rechange avec couvercle sans robinet

	Ø cm	↑ cm	ltr.	€
10417	25	42	10,5	43,00

Ersatz-Zapfhahn / replacement tap / grifo de recambio / robinet de rechange

	€
10718	26,00

Ersatz-Gestell / stand / soporte de recambio / support de remplacement

	Ø cm	↑ cm	€
10416	26	19	28,00



7 ltr.

### Getränkespender „OLD FASHIONED“

beverage dispenser  
dispensador de bebidas  
distributeur de boissons



Behälter aus Glas, Zapfhahn aus Edelstahl, Gestell schwarz

glass container, stainless steel tap, black stand

recipiente de vidrio, grifo de acero inoxidable, soporte negro

réceptien en verre, robinet en acier inox, support noir

	Ø cm	↑ cm	ltr.		€
10409	27	50,5	7	inkl. Gestell / incl. stand	90,00

Ersatz-Gestell / stand / soporte de recambio / support de remplacement

	Ø cm	↑ cm	€
10410	27	31,5	17,00

Ersatz-Glas / replacement glass / cristal de recambio / vitre de rechange

	Ø cm	↑ cm	ltr.	€
10411	19	36,5	7	49,00

Ersatz-Zapfhahn / replacement tap

	€
10718	26,00



**Saftdispenser „BRIDGE“**

juice dispenser  
dispensador de zumo  
distributeur à jus



**Kühlung durch 2 Kühllakkus von oben und unten**

cooling with 2 cooling elements from the top and base

2 acumuladores de frío: 1 en la base y 1 en la tapa

2 accumulateurs de froid: 1 dans le couvercle et 1 dans le socle

	cm	↑ cm	ltr.	Farbe / colour	€
10870	31,0 x 20	42	4	Ahorn / maple	248,00
10871	35,5 x 22	50	6	Ahorn / maple	290,00



**inklusive 3 Magnetschilder: ORANGE, APPLE, GRAPEFRUIT**  
including 3 magnetic signs: ORANGE, APPLE, GRAPEFRUIT



**Saftdispenser „BRIDGE“**

juice dispenser  
dispensador de zumo  
distributeur à jus



**Kühlung durch 2 Kühllakkus von oben und unten**

cooling with 2 cooling elements from the top and base

2 acumuladores de frío: 1 en la base y 1 en la tapa

2 accumulateurs de froid: 1 dans le couvercle et 1 dans le socle

	cm	↑ cm	ltr.	Farbe / colour	€
10872	31,0 x 20	42	4	Buche / beech	248,00
10873	35,5 x 22	50	6	Buche / beech	290,00



**inklusive 3 Magnetschilder: ORANGE, APPLE, GRAPEFRUIT**  
including 3 magnetic signs: ORANGE, APPLE, GRAPEFRUIT



**Adapter „TOP FRESH“**

adapter  
adaptador  
adaptateur



**handkontaktloser Adapter, einfach zu installieren**

adapter touchless for tap, easy to install

adaptador sin contacto para grifo

adaptateur sans contact manuel, facile à installer

	cm	↑ cm	€
10802	12 x 4,5	5,5	10,00



**Einfach den Adapter an der dafür vorgesehenen Öffnung auf den Hebel des Zapfhahns stecken.**

Simply plug the adapter onto the lever of the tap at the opening provided.



**Anschließend den Adapter nach unten festziehen. Durch das Nach-Vorne-Drücken des unteren Edelstahlbügels mit Hilfe des Glases, wird der Hebel des Zapfhahns betätigt und das Getränk fließt völlig handkontaktlos in das Glas.**

Then tighten the adapter downwards. By pushing the lower stainless steel bracket forward with the help of the glass, the lever of the tap is activated and the drink flows into the glass completely without hand contact.

## BEVERAGE DISPENSERS



10800 4 ltr.

10700 6 ltr.

### Saftdispenser „TOP FRESH“

juice dispenser  
dispensador de zumo  
distributeur à jus de fruit



hochglanzpoliert, Kühlung durch 2 Kühlakkus von oben und unten

mirror polished, cooling with 2 cooling elements from the top and base

pulido brillante, con 2 acumuladores de frío, 1 arriba y 1 en la base

poli brillant, 2 accumulateurs de froid, 1 dans le couvercle, 1 dans le socle

	cm	↑ cm	ltr.	€
10800	21 x 32	43	4	248,00
10700	23 x 35	52	6	350,00



2 x 6 ltr.

### Saftdispenser DUO „TOP FRESH“

juice dispenser  
dispensador de zumo  
distributeur à jus de fruit



hochglanzpoliert, Kühlung durch 2 Kühlakkus von oben und unten

mirror polished, cooling with 2 cooling elements from the top and base

pulido brillante, con 2 acumuladores de frío, 1 arriba y 1 en la base

poli brillant, 2 accumulateurs de froid, 1 dans le couvercle, 1 dans le socle

	cm	↑ cm	ltr.	€
10720	42 x 32	52	2 x 6	514,00



1) Deckel / cover / tapa / couvercle

	für ltr. / for ltr. / para ltr. / pour ltr.	€
10701	6	27,00
10801	4	23,00

2) Kühlakku / cooler / acumulador de frío / accumulateur de froid

	für ltr. / for ltr. / para ltr. / pour ltr.	€
10777	4 / 6	5,40

3) Behälter inklusive Zapfhahn / container incl. tap  
recipiente con grifo / récipient avec robinet

	für ltr. / for ltr. / para ltr. / pour ltr.	€
10703	6	178,00
10803	4	152,00

3) Behälter ohne Zapfhahn / container without tap  
recipiente sin grifo / récipient sans robinet

	für ltr. / for ltr. / para ltr. / pour ltr.	€
10704	6	134,00
10804	4	112,00

4) Non-Drip Hahn / non-drip tap / grifo anti-goteo / robinet anti-goutte

	für ltr. / for ltr. / para ltr. / pour ltr.	€
10707	6	58,00
10807	4	56,00

5) Einsatz / insert / aro inox / cercle inox

	für ltr. / for ltr. / para ltr. / pour ltr.	€
10708	6	4,40
10808	4	4,40

6) Standfuß 18/10 Edelstahl / column 18/10 stainless steel  
base inox 18/10 / socle inox 18/10

	für ltr. / for ltr. / para ltr. / pour ltr.	€
10709	6	74,00
10809	4	56,00

7) Tropfgitter 18/10 Edelstahl / drip lattice 18/10 stainless steel  
rejilla recoge gotas 18/10 / grille ramasse-gouttes 18/10

	für ltr. / for ltr. / para ltr. / pour ltr.	€
10712	6	26,00
10713	DUO	46,00
10812	4	23,00

8) Bodenplatte 18/10 Edelstahl / footing 18/10 stainless steel  
base de 18/10 acero / socle inox 18/10

	für ltr. / for ltr. / para ltr. / pour ltr.	€
10710	6	51,00
10711	DUO / 6 + 6	108,00
10814	4	35,00

1 x Dichtung, 2 x Dichtungsring (transparent), 1 x Dichtungsring (s / w)  
1 x seal, 2 x sealing ring (transparent), 1 x sealing ring (b / w)

Zubehör / Reinigungsset - für die regelmäßige Reinigung

	für Zapfhahn	€
10714	für Zapfhahn 10707	4,20
10715	für Zapfhahn 10807	4,20





7,5 ltr.

300 ml

7,5 ltr.

**Getränkespender „NORDIC WOOD“**

beverage dispenser  
dispensador de bebidas  
distributeur de boissons



**Behälter mit Edelstahlzapfhahn und Korkdeckel, stabiles Glas, inklusive Bambus-Standfuß und Kork-Untersetzer**

container with stainless steel tap and cork cover, solid glas, including bamboo base and cork coaster

recipiente con grifo de acero inoxidable y tapa de corcho, cristal sólido, incluye soporte de bambú y posavasos de corcho

réipient avec robinet en acier inox et couvercle en liège, verre robuste, y compris pied en bambou et dessous de verre en liège

	cm	↑ cm	ltr.	€
10435	23 x 23	60,5	7,5	106,00

**Trinkbecher „CRYSTAL“**  
drinking cup / vaso / gobelet



	Ø cm	↑ cm	ltr.	VE	€ / pc.
10501	8	12,5	0,3	48	4,40

**Ersatzteile Getränkspender „NORDIC WOOD“**

parts beverage dispenser  
recambios dispensador de bebidas  
pièces distributeur de boissons

**Ersatz-Deckel / replacement lid / tapa de recambio / couvercle de rechange**

	Ø cm	↑ cm	€
10428	11,5	1,5	5,90

**Ersatz-Glas inklusive Zapfhahn / replacement glass with tap / cristal de recambio con grifo / vitre de rechange avec robinet**

	Ø cm	↑ cm	ltr.	€
10427	17	46	7,5	57,00

**Ersatz-Untersetzer aus Kork / replacement cork coaster / posavasos de corcho de recambio / soucoupes de liège de rechange**

	Ø cm	↑ cm	€
10424	16,5	1,5	6,00

**Ersatz-Gestell / stand for / soporte de recambio / support de remplacement**

	cm	↑ cm	Farbe / colour	€
10426	23 x 23	14		23,00



**Getränkespender „FRESH WOOD“**

beverage dispenser  
dispensador de bebidas  
distributeur de boissons



**Behälter mit Edelstahlzapfhahn und Korkdeckel, stabiles Glas, inklusive Bambus-Standfuß und Kork-Untersetzer**

container with stainless steel tap and cork cover, solid glas, including bamboo base and cork coaster

recipiente con grifo de acero inoxidable y tapa de corcho, cristal sólido, incluye soporte de bambú y posavasos de corcho

réipient avec robinet en acier inox et couvercle en liège, verre robuste, y compris pied en bambou et dessous de verre en liège

	cm	↑ cm	ltr.	€
10430	23 x 23	56,5	4,5	106,00

**Trinkbecher „CRYSTAL“**

drinking cup / vaso / gobelet



	Ø cm	↑ cm	ltr.	VE	€ / pc.
10501	8	12,5	0,3	48	4,40

**Tropfenschale / drip tray / aro anti-goteo / anneau coupe-gouttes**



	Ø cm	↑ cm	Farbe / colour	€
10851	9,5	1,5	White	8,00



**Ersatzteile Getränkespender „FRESH WOOD“**

spare parts beverage dispenser  
recambios dispensador de bebidas  
pièces distributeur de boissons

**Ersatz-Deckel / replacement lid / tapa de recambio / couvercle de rechange**

	Ø cm	↑ cm	Farbe / colour	€
10428	11,5	1,5	Orange	5,90

**Ersatz-Glas inklusive Zapfhahn / replacement glass with tap / cristal de recambio con grifo / vitre de rechange avec robinet**

	Ø cm	↑ cm	ltr.	€
10422	15,5	42,0	4,5	55,00

**Ersatz-Untersetzer aus Kork / replacement cork coaster / posavasos de corcho de recambio / soucoupes de liège de rechange**

	Ø cm	↑ cm	€
10424	16,5	1,5	6,00

**Ersatz-Gestell / stand for / soporte de recambio / support de remplacement**

	cm	↑ cm	Farbe / colour	€
10426	23 x 23	14	Orange	23,00

## BEVERAGE DISPENSERS



### Milchdispenser „BRIDGE“

milk dispenser  
dispensador de leche  
distributeur à lait



**Edelstahl Dispenser mit 1 Kühllakku im Standfuß inklusive touchless adapter**

stainless steel dispenser with 1 cooling element in stand including touchless adapter  
dispensador de acero inoxidable con 1 acumulador de frío en la base y con adaptador sin contacto para grifo  
distributeur en acier inox avec 1 accumulateur de froid dans le socle et avec adaptateur sans contact manuel

	cm	↑ cm	ltr.	Farbe / colour		€
10836	31 x 20	39	3	 Ahorn / maple		290,00



### Milchdispenser „BRIDGE“

milk dispenser  
dispensador de leche  
distributeur à lait



**Edelstahl Dispenser mit 1 Kühllakku im Standfuß inklusive touchless adapter**

stainless steel dispenser with 1 cooling element in stand including touchless adapter  
dispensador de acero inoxidable con 1 acumulador de frío en la base y con adaptador sin contacto para grifo  
distributeur en acier inox avec 1 accumulateur de froid dans le socle et avec adaptateur sans contact manuel

	cm	↑ cm	ltr.	Farbe / colour		€
10837	31 x 20	39	3	 Buche / beech		290,00



### Saftdispenser „INOX STAR“

juice dispenser  
dispensador de zumo  
distributeur à jus de fruit



**Edelstahl-Crushed Ice Röhre herausnehmbar**

removable stainless steel crash ice tube  
con tubo inox refrigerante extraíble para hielo picado  
avec tube inox réfrigérant amovible pour glace pilée

	cm	↑ cm	ltr.		€
10795	36 x 26	55	8		190,00

**Behälter / container / recipiente / récipient**

	Ø cm	ltr.		€
10796	22	8		35,70



**Milchkanne „TOP FRESH“**

milk dispenser  
dispensador de leche  
distributeur à lait



hochglanzpoliert, 1 Kühlakku im Standfuß, „original Milchkanne mit Henkel“

mirror polished, 1 cooler in base, original milkcan  
pulido brillante, 1 acumulador de frío en la base, recipiente „lechera“  
poli brillant, 1 accumulateur de froid dans le socle, design „pot à lait“

	cm	↑ cm	ltr.	€
10830	21 x 32	39	3	320,00
10750	23 x 35	45	5	510,00

**Milchkanne ohne Zapfhahn** / milkcan without tap / jarra de leche sin grifo / récipient à lait sans robinet

	Ø cm	↑ cm	ltr.	€
10833	16	22	3	174,00
10663	22	26	5	210,00



**Milchkanne „TOP FRESH“**

milk dispenser  
dispensador de leche  
distributeur à lait



inklusive Porzellanschild zum Beschriften, 1 Kühlakku im Fuß

including porcelain sign, 1 cooler in base  
incluye cartelito en porcelana, 1 acumulador de frío en la base  
indicateur en porcelaine inclus, 1 accumulateur de froid dans le socle

	cm	↑ cm	ltr.	€
10850	31 x 21	42	4	300,00



**Milchkanne „TOP FRESH“**

milk dispenser  
dispensador de leche  
distributeur à lait



Buchenholz versiegelt, inklusive Porzellanschild zum Beschriften, 1 Kühlakku im Fuß

beech wood, waterproof, incl. porcelain sign, 1 cooler in base  
madera de haya, resistente al agua, incluye placa de porcelana, 1 acumulador de frío en la base  
socle bois hêtre traité, indicateur en porcelaine inclus, 1 accumulateur de froid dans le socle

	cm	↑ cm	ltr.	€
10840	23 x 32	42	4	300,00



**Iso-Dispenser**

insulated dispenser  
dispensador isotérmico  
distributeur de boisson isothermique



für heiÙe und kalte Getrânke / for hot and cold drinks / para bebidas frías y calientes /  
pour boissons chaudes ou froides

	Ø cm	↑ cm	ltr.	€
10788	24	42	9,5	62,00

**Hahn** / tap / grifo / robinet

10789				12,00
-------	--	--	--	-------

# CARAFES



0,75 ltr.

## Glaskaraffe „DOTS“

glass carafe  
jarra de vidrio  
carafe en verre

GLASS CORK

ideal für Cerealien, Säfte oder Milch, Deckel aus Kork

ideal for cereals, juices or milk, cork lid

ideal para cereales, zumos o leche, tapa de corcho

idéal pour les céréales, les jus de fruits ou le lait, couvercle en liège

	Ø cm	↑ cm	ltr.	fits to	€
10739	8	28	0,75	14019	20,00



0,75 ltr.

## Glaskaraffe „LINES“

glass carafe  
jarra de vidrio  
carafe en verre

GLASS CORK

ideal für Cerealien, Säfte oder Milch, Deckel aus Kork

ideal for cereals, juices or milk, cork lid

ideal para cereales, zumos o leche, tapa de corcho

idéal pour les céréales, les jus de fruits ou le lait, couvercle en liège

	Ø cm	↑ cm	ltr.	fits to	€
10738	8	28	0,75	14019	20,00



## 1er-Podest für Glaskaraffen „VALO“

podest for 1 glass carafe  
pedestal para 1 jarra de vidrio  
podium pour 1 pichet en verre

OAK WOOD   

ideal für eine stets geordnete Präsentation am Buffet

ideal for a constantly organised presentation at the buffet

ideal para una presentación constantemente organizada en el buffet

idéal pour une présentation toujours ordonnée au buffet

	cm	↑ cm	fits to	€
14019	15 x 15	12	10738	15,00



**Glaskaraffe „LINES“**

glass carafe  
jarra de vidrio  
carafe en verre

GLASS CORK

ideal für Cerealien, Säfte oder Milch, Deckel aus Kork

ideal for cereals, juices or milk, cork lid

ideal para cereales, zumos o leche, tapa de corcho

idéal pour les céréales, les jus de fruits ou le lait, couvercle en liège

	Ø cm	↑ cm	ltr.	fits to	€
10725	9	19,5	0,5	14023, 14123	15,00
10726	9	27,5	1,0	14023, 14123	21,00
10727	9	35,0	1,5	14023, 14123	22,00



10725 0,5 ltr.  
10726 1,0 ltr.  
10727 1,5 ltr.



**3er-Podest für Glaskaraffen „VALO“**

podest for 3 glass carafes  
pedestal para 3 jarras de vidrio  
podium pour 3 pichets en verre

OAK WOOD made in EU

ideal für eine stets geordnete Präsentation am Buffet

ideal for a constantly organised presentation at the buffet

ideal para una presentación constantemente organizada en el buffet

idéal pour une présentation toujours ordonnée au buffet

	cm	↑ cm	fits to	Farbe / colour	€
14023	41 x 16	12	10725, 10726, 10727, 10735	oiled	49,00
14123 <b>NEW</b>	41 x 16	12	10725, 10726, 10727, 10735	lacquered	54,00



**Wein- / Sektkühler „AUREO“**

wine / champagne bowl  
cubitera para vino y cava  
seau à vin ou champagne

PLASTIC 18/8 STAINLESS STEEL

hochwertige äußere Facettierung, Rand & Bodenring in Gunmetal-Look

high-quality outer bevelling, rim & base ring in gunmetal look

facetas exteriores de alta calidad, aro y anillo de base en gunmetal

facetage extérieur de haute qualité, bord & anneau de fond en look gunmetal

	Ø cm	↑ cm	ltr.	€
36160	28	25	10	44,00





NEW

**Glaskaraffe „LINES“**

glass carafe  
jarra de vidrio  
carafe en verre

GLASS CORK

ideal für Milch oder Säfte, Deckel aus Kork

ideal for milk or juices, cork lid

ideal para leche o zumos, tapa de corcho

idéal pour le lait ou les jus de fruits, couvercle en liège

	Ø cm	↑ cm	ltr.	fits to	€
10735	9	27	1	10736, 14023, 14123	21,00



NEW

**Labelclips, 4er Set**

label clips, set of 4  
etiqueta clip, set de 4  
étiquette clip, set de 4

STAINLESS STEEL

vier verschiedene Beschriftungen (milk, oat, almond, soy) – passend für Glaskaraffe Nr. 10735

four different labels (milk, oat, almond, soy) – suitable for glass carafe no. 10735

cuatro etiquetas diferentes (milk, oat, almond, soy) – aptas para jarra de cristal no. 10735

quatre inscriptions différentes (milk, oat, almond, soy) – pour la carafe en verre no. 10735

	Ø cm	↑ cm	fits to	pcs.	€ / set
10736	4,5	2,5	10735	4	8,80

NEW



2,0 ltr.

**Saft- & Wasserkanne**  
 juice & water pitcher  
 jarra de zumo & agua  
 pichet à eau & jus de fruit



mit Edelstahldeckel und integriertem Sieb – ideal für Wasser, Saft oder Infused-Drinks  
 with stainless steel lid and integrated strainer – ideal for water, juice, or infused drinks  
 con tapa de acero inoxidable y colador integrado – ideal para agua, zumo o bebidas infusionadas  
 avec couvercle en acier inox et filtre intégré – idéal pour l'eau, les jus ou les boissons infusées

	Ø cm	↑ cm	ltr.	€
10728	13	23	2	21,00



2-farbig / 2 colours





1 ltr.

**Glaskaraffe**  
glass carafe  
jarra de vidrio  
pichet en verre

**der Deckel öffnet sich beim Ausgießen automatisch**  
cover opens automatically while pouring  
la tapa se abre automáticamente durante el vertido  
le couvercle s'ouvre seul pendant le service

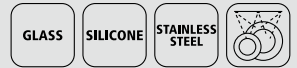

	Ø cm	↑ cm	ltr.	€
10766	10	29	1	24,00



1 ltr.

10721

**Glaskaraffe**  
glass carafe  
jarra de vidrio  
carafe en verre

**Deckel aus Edelstahl matt poliert, Ausgießer für tropffreies Ausgießen**  
lid made of matt polished stainless steel, spout for drip-free pouring  
tapa de acero inoxidable pulido mate, pico para verter sin gotear  
couvercle en acier inox poli mat, bec verseur pour verser sans goutter



	Ø cm	↑ cm	ltr.	€
10721	8	25	1,0	16,00
10722	8	32	1,3	18,20



1,5 ltr.

**Soft- / Wasserkanne**  
juice / water pitcher  
jarra de zumo / agua  
pichet à eau ou jus de fruit

**Deckel aus Edelstahl matt poliert, Ausgießer für tropffreies Ausgießen**  
stainless steel cover, matt polished, spout for drip-free pouring  
tapa de acero inoxidable pulido mate, pico para verter sin gotear  
couvercle en acier inox poli mat, bec verseur pour verser sans goutter



	Ø cm	↑ cm	ltr.	€
10764	9,5	27	1,5	25,60



1,5 ltr.

**Soft- / Wasserkanne**  
juice / water pitcher  
jarra de zumo / agua  
pichet à eau ou jus de fruit

**Deckel aus Edelstahl matt poliert, mit integriertem Auffangsieb für Kerne oder Eis**  
lid made of matt polished stainless steel, with integrated strainer for cores or ice  
tapa de acero inoxidable pulido mate, con filtro integrado para los huesos o el hielo  
couvercle en acier inox poli mat, avec filtre intégré pour les pépins ou la glace



	Ø cm	↑ cm	ltr.	€
10792	10	26	1,5	21,00



**Deckel mit Doppelfunktion**  
lid with double function



**Saft- / Wasserkanne**  
 juice / water pitcher  
 jarra de zumo / agua  
 pichet à eau ou jus de fruit

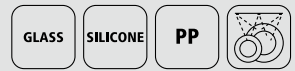

**Deckel mit Auffangsieb für Kerne oder Eis**  
 lid with integrated strainer for cores or ice  
 tapa con filtro integrado para los huesos o el hielo  
 couvercle avec filtre intégré pour les pépins ou la glace

	Ø cm	↑ cm	ltr.	€
10691	12	26	1,8	14,80



**Wasserkanne**  
 water pitcher  
 jarra de agua  
 pichet à eau



**hochglanzpoliert, mit Ausgieß-Stopper für Eiswürfel oder Früchte**  
 mirror-polished, with pouring stopper for ice cubes or fruit  
 pulido brillante, con tope vertedor para cubios de hielo o fruta  
 poli brillant, avec arrêt de versement pour les glaçons ou les fruits

	Ø cm	↑ cm	ltr.	€
10695	9	27,5	1,2	21,00



**Saft- / Wasserkanne**  
 juice / water pitcher  
 jarra de zumo / agua  
 pichet à jus de fruit / eau



**Deckel aus Edelstahl mit Silikondichtung, mit integriertem Auffangsieb für Kerne oder Eis**  
 stainless steel lid with silicone seal, with integrated strainer for cores or ice  
 tapa de acero inoxidable con junta de silicona, con filtro integrado para los huesos o el hielo  
 couvercle en acier inox avec joint en silicone, avec filtre intégré pour les pépins ou la glace

	Ø cm	↑ cm	ltr.	€
10692	10	19	1	17,00
10693	11,5	24	1,8	20,00



**Deckel mit Doppelfunktion**  
 lid with double function



3 ltr.

**Saft- / Wasserkanne**  
juice / water pitcher  
jarra de zumo / agua  
pichet à eau ou jus de fruit

**mit Eiswasserröhre**  
with water ice tube  
con tubo para hielo  
avec tube à glaçons plongeant pour réfrigérer



	Ø cm	↑ cm	ltr.	€
10770	18	29	3	29,60



2,8 ltr.

**Saft- / Wasserkanne**  
juice / water pitcher  
jarra de zumo / agua  
pichet à eau ou jus de fruit

**mit Eiswasserröhre / with water ice tube / con tubo para hielo / avec tube d'eau glacée**



	cm	↑ cm	ltr.	€
10769	19 x 13	27	2,8	25,00



2 ltr.

**Saft- / Wasserkanne**  
juice / water pitcher  
jarra de zumo / agua  
pichet à eau ou jus de fruit



	Ø cm	↑ cm	ltr.	€
10775	12	26	2,0	24,00



2,5 ltr.

**Saft- / Wasserkanne**  
juice / water pitcher  
jarra de zumo / agua  
pichet à eau ou jus de fruit



	Ø cm	↑ cm	ltr.	€
10776	14	29	2,5	21,00





1,6 ltr.

**Karaffe**  
carafe  
jarra  
carafe



**Schraubdeckel mit aromadichtem Verschluss**

screw lid with flavour-tight seal

tapa de rosca con cierre hermético para conservar el aroma

couvercle à vis avec fermeture hermétique préservant les arômes

	Ø cm	↑ cm	ltr.	€
10771	11	30	1,6	16,00



10748 1 ltr.

10749 1 ltr.

**Flasche „STRIPES“**

bottle  
botella  
bouteille



	Ø cm	↑ cm	ltr.	Farbe / colour	€
10748	9	28,5	1		13,20
10749	9	28,5	1		13,20



Flaschenverschluss  
bottle top



1,5 ltr.

**Pitcher**

pitcher  
jarra  
pichet



	Ø cm	↑ cm	ltr.	€
93105	13	21	1,5	10,40



einfaches Ausgießen  
easy pouring out

**NEW** EVERLINE



**Trinkflasche „EVERLINE“**

drinking bottle  
botella para beber  
gourde

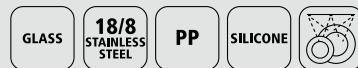

facettiertes Liniendesign, Trinkflasche aus Glas, Deckel aus Edelstahl  
faceted line design, glass drinking bottle, stainless steel lid  
diseño de líneas facetadas, botella de vidrio, tapa de acero inoxidable  
design de ligne à facettes, gourde en verre, couvercle en acier inox

	Ø cm	↑ cm	ltr.	€
66950	6,5	19,5	0,4	5,60
66951	6,5	23,0	0,5	6,10
66952	7,0	26,0	0,7	6,60



mit Schraubverschluss  
with screw cap



# EVERFILL



## Trinkflasche „EVERFILL“

drinking bottle  
botella para beber  
gourde



Trinkflasche aus Glas, Deckel aus Edelstahl  
glass drinking bottle, stainless steel lid  
botella de vidrio, tapa de acero inoxidable  
gourde en verre, couvercle en acier inox

	Ø cm	↑ cm	ltr.	€
66935 <small>NEW</small>	6,5	15,0	0,30	4,40
66936 <small>NEW</small>	6,5	18,0	0,40	4,80
66907	6,5	23,5	0,55	5,00
66908	7,0	26,5	0,75	6,10
66909	7,5	28,5	1,00	7,20



mit Schraubverschluss  
with screw cap



## BEVERAGE BOWLS



### Flaschenkühler „BIG BOWL“

bottle cooler  
enfriador de botella  
rafraîchisseur de bouteille

gehämmert, innen matt poliert, herausnehmbarer Tropfeinsatz  
hammered, inside matt polished, removable drip tray  
martillada, interior pulido mate, bandeja de goteo extraíble  
martelée, intérieur poli mat, bac d'égouttage amovible



	Ø cm	↑ cm	ltr.	€
36130	37	23	8	240,00



### Getränkewanne „TIN“

beverage tub  
barreño botellines  
bassine à glace

Metall verzinkt, mit Kunststoffeinsatz  
galvanised metal, with plastic insert  
metal galvanizado, con inserto de plástico  
métal galvanisé, avec insert en plastique



	cm	↑ cm	ltr.	Farbe / colour	€
36100	40 x 28	22	11	copper-look	36,00
36101	40 x 28	22	11	black-metal-look	31,00
36095	40 x 28	22	11	metal-look	30,00
36096	50 x 23	23	18	metal-look	36,00

Ersatzeinsatz / replacement plastic insert / inserto de plástico / insert en plastique

	cm	↑ cm	fits to	€
36097	38 x 26,5	20,5	36100, 36101, 36095	10,00
36098	47 x 31	21,5	36096	12,00



Kreidestift zum Beschriften  
chalk marker for writing



36111 7 ltr.

36112 7 ltr.

**Wein- / Sektkühler „XL“**

wine / champagne bowl  
cubitera para vino y cava  
seau à vin ou champagne

**gehämmert, mit 2 seitlichen Eingriffen**

hammered, with 2 handles on the side  
martillada, con 2 asas  
martelée, avec 2 poignées



	cm	↑ cm	ltr.	Farbe / colour	€
36111	30 x 23,5	23	7	copper-look	68,00
36112	30 x 23,5	23	7	gunmetal-look	68,00



36109 3,9 ltr.

36108 3,9 ltr.

**Wein- / Sektkühler „LARGE“**

wine / champagne bowl  
cubitera para vino y cava  
seau à vin ou champagne

**gehämmert, mit 2 seitlichen Eingriffen, für 1-2 Flaschen**

hammered, with 2 handles on the side, for 1-2 bottles  
martillada, con 2 asas, para 1-2 botellas  
martelée, avec 2 poignées, pour 1-2 bouteilles



	cm	↑ cm	ltr.	Farbe / colour	€
36108	25,5 x 19	20	3,9	copper-look	37,00
36109	25,5 x 19	20	3,9	gunmetal-look	37,00



36106 2,1 ltr.

36107 2,1 ltr.

**Wein- / Sektkühler „SMALL“**

wine / champagne bowl  
cubitera para vino y cava  
seau à vin ou champagne

**gehämmert, für 1 Flasche**

hammered, for 1 bottle  
martillada, para 1 botella  
martelée, pour 1 bouteille



	cm	↑ cm	ltr.	Farbe / colour	€
36106	20,5 x 14	17	2,1	copper-look	27,00
36107	20,5 x 14	17	2,1	gunmetal-look	27,00

## TEAPOTS



### Teekanne „ASIA“

teapot  
tetera  
théière



aus Gusseisen, innen emailliert, abnehmbarer Deckel, mit Teesieb aus Edelstahl

made of cast iron, enamelled inside, removable lid, with tea strainer made of stainless steel  
hierro fundido, interior esmaltado, tapa extraíble, con colador de té de acero inoxidable  
en fonte, émaillé à l'intérieur, couvercle amovible, avec une passoire à thé en acier inox

	cm	↑ cm	ltr.	€
10995	17 x 14	17	0,8	26,00



### Teekanne „ASIA“

teapot  
tetera  
théière



aus Gusseisen, innen emailliert, abnehmbarer Deckel, mit Teesieb aus Edelstahl

made of cast iron, enamelled inside, removable lid, with tea strainer made of stainless steel  
hierro fundido, interior esmaltado, tapa extraíble, con colador de té de acero inoxidable  
en fonte, émaillé à l'intérieur, couvercle amovible, avec une passoire à thé en acier inox

	cm	↑ cm	ltr.	€
10991	19,5 x 18	15	0,8	26,00



### Teekanne „ASIA“

teapot  
tetera  
théière



aus Gusseisen, innen emailliert, mit abnehmbarem Deckel, ohne Teesieb aus Edelstahl

made of cast iron, enamelled inside, with removable lid, without tea strainer made of stainless steel  
hierro fundido, interior esmaltado, con tapa extraíble, sin colador de té de acero inoxidable  
en fonte, émaillé à l'intérieur, avec couvercle amovible, sans une passoire à thé en acier inox

	cm	↑ cm	ltr.	€
10990	12,5 x 11	12,5	0,3	21,00



### Stövchen „ASIA“

teapot warmer  
calentador de tetera  
chauffe-théière



1-flammiges Stövchen aus Gusseisen mit abnehmbarem Deckel (Lieferung ohne Teelicht).

1-flame cast iron warmer with removable lid (delivery without tealight).

calentador de tetera de hierro fundido con 1 quemador con tapa extraíble (se entrega sin vela).

chauffe-théière en fonte à 1 brûleur avec couvercle amovible (livraison sans bougie).

	Ø cm	↑ cm	€
10994	13	7,5	16,40

Untersetzer aus Gusseisen mit Antirutschfüßchen / cast iron coaster with non-slip feet

	Ø cm	↑ cm	€
10993	13,5	1,5	5,50



### Tablett

tray  
bandeja  
plateau



	cm	↑ cm	GN	€
00845	32,5 x 26,5	3	1/2	13,00



11575



11574

**Teebox**

tea-box  
caja para té  
boîte à thés et infusions



**Box aus Rubberwood mit Sichtfenster, mit Aufschrift „Tee“, 4 Kammern können mit je 30 kuvertierten Teebeuteln bestückt werden**

rubber wood box with clear transparent window, with inscription „Tee“, 4 chambers for approx. 30 tea bags each

caja de madera de goma clara con ventana transparente, con inscripción „Tee“, 4 compartimentos, y cada uno para aproximadamente 30 bolsitas de té en bois d'hévéa clair avec fenêtre, avec inscription „Tee“, 4 compartiments, pour environ 30 sachets chacun

	cm	↑ cm	Farbe / colour	€
11575	33,5 x 20	9		21,00
11574	33,5 x 20	9		21,00

	cm	↑ cm	Farbe / colour	€
11576	33,5 x 20	9		21,00

ohne Aufschrift / without inscription  
sin inscripción / sans inscription



11775



11776

**Teebox**

tea-box  
caja para té  
boîte à thés et infusions



**Box aus Rubberwood mit Sichtfenster, mit Aufschrift „Tee“, 12 Kammern können mit je 12 kuvertierten Teebeuteln bestückt werden**

rubber wood box with clear transparent window, with inscription „Tee“, 12 chambers for approx. 12 tea bags each

caja de madera de goma clara con ventana transparente, con inscripción „Tee“, 12 compartimentos, y cada uno para aproximadamente 12 bolsitas de té en bois d'hévéa clair avec fenêtre, avec inscription „Tee“, 12 compartiments, pour environ 12 sachets chacun

	cm	↑ cm	Farbe / colour	€
11775	31 x 28	9		28,00
11776	31 x 28	9		28,00

**Teebox / Multibox**

tea caddy  
caja para té  
boîte à thés et infusions



**3 Fächer für kuvertierte Teebeutel, 1 Fach für Zucker, Kekse, etc., Deckel aufklappbar**

3 compartments for tea bags, 1 compartment for sugar, biscuits, etc., hinged lid

3 compartimentos para bolsitas de té, 1 compartimento para azúcar, galletas, etc. tapa abatible  
3 compartiments pour sachets de thé, 1 compartiment pour sucre, biscuits, etc., couvercle abatible

	cm	↑ cm	€
11563	22 x 17	9	21,00



# VACUUM JUGS



**Deckel klappbar**  
lid foldable



10924 1,5 ltr.

## Isolierkanne „ADVANCED“

vacuum jug  
jarra termo  
bouteille isotherme



doppelwandig, Einhandautomatik, aufgeklappt passt die Kanne unter die gängigen Kaffeeautomaten, für heiße und kalte Getränke

double-walled, easy pouring system, with flipped-back lid, the air pot fits under a wide range of coffee makers, for hot and cold beverages

doble pared, se maneja con 1 mano, con la tapa abierta la jarra se puede usar con casi todas las cafeteras corrientes, para bebidas frías y calientes

double paroi, usage à 1 main, avec la couvercle ouverte a bouteille se peut user avec toutes les machines à café courantes, pour boissons chaudes ou froides

	Ø cm	↑ cm	ltr.	Anzahl der Tassen	€
10921	10,5	13,0	0,3	2,5	45,00
10922	10,5	18,0	0,6	5,0	52,00
10923	13,0	19,5	1,0	8,0	58,00
10924	13,0	23,5	1,5	12,0	65,00



10912 2 ltr.

## Isolierkanne „ESSENTIAL“

vacuum jug  
jarra termo  
bouteille isotherme



doppelwandig, Einhandautomatik, Drehverschluss, für heiße und kalte Getränke

double-walled, easy push-button pouring system, screw cap, for hot and cold drinks

doble pared, se maneja con 1 mano, con tapa a rosca, para bebidas frías y calientes

double paroi, usage à 1 main, couvercle à visser, pour boissons chaudes ou froides

	Ø cm	↑ cm	ltr.	Anzahl der Tassen	€
10910	14	19	1,0	8	16,90
10911	14	22	1,5	12	18,40
10912	14	25	2,0	16	21,20



10913



10914

## Isolierkanne „ECONOMY“

vacuum jug  
jarra termo  
bouteille isotherme



robuste Umhüllung mit Polypropylen-Kunststoff, Stabilglaseinsatz, Drehverschluss mit Drucktasten-Bedienung für heiße und kalte Getränke, 8 Tassen

double-walled with glass liner, screw cap with easy push-button pouring system, for hot and cold beverages, 8 cups

exterior de plástico polipropileno, interior aislante de vidrio, con tapa a rosca con cierre dosificador para bebidas frías y calientes, 8 tazas

extérieur en plastique polypropylène, intérieur avec plaque de verre, couvercle à visser, pour boissons chaudes ou froides, 8 tasses

	Ø cm	↑ cm	ltr.	Farbe / colour	€
10913	16	20	1	White	17,40
10914	16	20	1	Black	17,40



**Kaffeedispenser „HAPPY HOUR“**

coffee dispenser  
dispensador de café  
distributeur de café



hochglanzpoliert, für warme Getränke, stabil und standfest, inklusive 1 Brennpastenbehälter  
mirror polished, for warm drinks, solid and stable, including 1 burner holder  
pulido brillante, para bebidas calientes, sólido y estable, incluye un calentador  
poli brillant, pour boissons chaudes, robuste et stable, avec 1 brûleur

	cm	↑ cm	ltr.	€
11672	31 x 33,5	54,5	10,5	210,00

**Hahn / tap / grifo / robinet**

	€
11671	27,00

**Elektro-Heizelement / heating unit / resistencia / résistance**

	cm	↑ cm	€
12287	21 x 20	6	99,00



**Pump-Isolierkanne „PRIME“**

air pot  
jarra termo  
bouteille isotherme



matt poliert, doppelwandig, Tragegriff, Drehverschluss, Pumpmechanismus, Füllstandsanzeigefür heiße und kalte Getränke, inklusive 4 Beschriftungsclips, für 24 Tassen

matt polished, double-walled, carrying handle, screw cap, pump mechanism, fill level indicator, for hot and cold beverages, including 4 beverage signs, for 24 cups

pulido mate, doble pared, asa de transporte, tapón de rosca, mecanismo de bombeo, indicador de nivel para bebidas calientes y frías, con 4 clips para marcar, para 24 tazas

poli mat, double paroi, poignée de transport, fermeture rotative, mécanisme de pompage, indicateur de niveau pour boissons chaudes et froides, avec 4 clips d'inscriptions, pour 24 tasses

	Ø cm	↑ cm	ltr.	Anzahl der Tassen	€
10916	15	37	3	24	70,00

**Tropfenfänger für Pump-Isolierkanne / drip tray for air pot / recogegotas para jarra termo / ramasse-gouttes pour bouteilles isotherme**

	cm	↑ cm	€
10917	24 x 18,5	4	11,40



**Pump-Isolierkanne „BUDGET“**

air pot  
jarra termo  
bouteille isotherme



Edelstahl, Polypropylen, matt poliert, doppelwandig, Tragegriff, Dreh-Pumpknopf, für heiße und kalte Getränke, für 17 Tassen

stainless steel, polypropylene, matt polished, double-walled, carrying handle, push-button, for hot and cold beverages, for 17 cups

acero inoxidable, polipropileno, pulido mate, doble pared, asa de transporte, botón giratorio de la bomba, para bebidas calientes y frías, para 17 tazas

acier inox, polypropylène, poli mat, double paroi, poignée de transport, bouton de pompage rotatif, pour boissons chaudes et froides, pour 17 tasses

	Ø cm	↑ cm	ltr.	Anzahl der Tassen	€
10915	13,5	32,5	2,2	17	28,00

# NATURAL SLATE



**EXTRA STRONG**  
6-9 mm thickness  
broken edges



3 tlg.  
3 pcs.

## Kühlbox „MORRA“ refrigerated buffet display expositor buffet frío plateau buffet froid

3-teilig, bestehend aus: 1 Basis aus schwarzem Polystyrol,  
1 Naturschieferplatte, 1 Kühlakku (ohne Haube)  
3 pcs., set consists of: 1 base made of black polystyrene, 1 natural slate tray,  
1 cooler (without cover)

set de 3 compuesto por: 1 soporte de poliestireno negro, 1 bandeja de pizarra natural,  
1 acumulador de frío (sin campana)

set de 3 composé de: 1 support en polystyrène noir, 1 plateau en ardoise naturelle,  
1 accumulateur de froid (sans couvercle)



	cm	↑ cm	€
11645	58 x 38	6,5	80,00

## Naturschieferplatte / natural slate tray / bandeja de pizarra natural / plateau ardoise naturelle

	cm	* mm	€
00979	58 x 38	6 - 9	19,00

## Kühlakku / cooler / acumulador de frío / accumulateur de froid

	cm	↑ cm	€
10782	41 x 21	2,5	16,00

## Basis / base / soporte / support

	cm	↑ cm	€
11619	52 x 32	5,5	49,00

## GN Rolltophaube mit schwarzem Griff / GN rolltop cover with black handle / GN campana rolltop con mango negro / GN cloche rolltop avec poignée noire

	cm	↑ cm	GN	€
11075	53 x 32,5	19	1/1	62,00



## GN 1/1 Naturschieferplatte „MORRA“

GN 1/1 natural slate tray  
GN 1/1 bandeja de pizarra natural  
GN 1/1 plat ardoise naturelle



	cm	↑ cm	* mm	€
00966	53 x 32,5	6	6 - 9	35,80



Griffe verchromt, 4 cm Nutzhöhe  
chrome plate handles, 4 cm distance

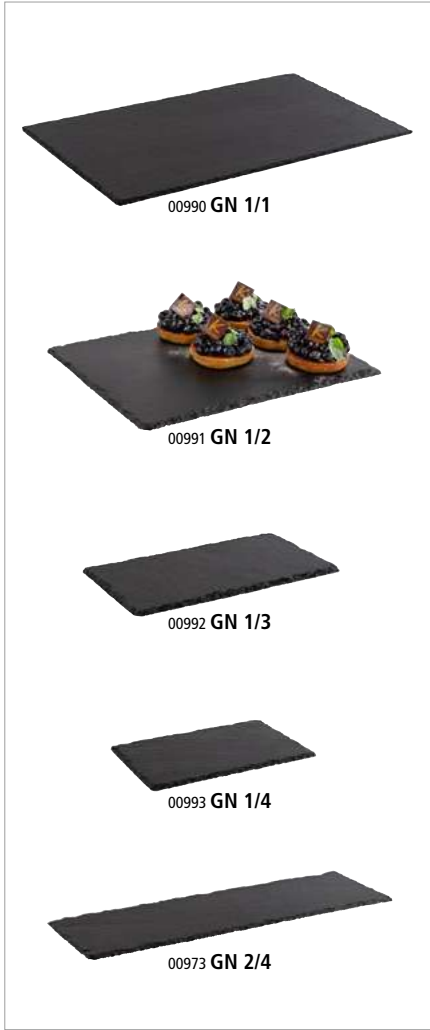

**GN Naturschieferplatten „MORRA“**

GN natural slate tray  
GN bandeja de pizarra natural  
GN plat ardoise naturelle

**gebrochene Kanten**

broken edges  
bordes biselados  
bords biseautés



	cm	✱ mm	GN	€
00990	53,0 x 32,5	6 - 9	1/1	15,80
00991	32,5 x 26,5	6 - 9	1/2	8,80
00992	32,5 x 17,6	6 - 9	1/3	5,40
00993	26,5 x 16,2	6 - 9	1/4	5,00
00973	53,0 x 16,2	6 - 9	2/4	6,50



gebrochene Kanten  
broken edges

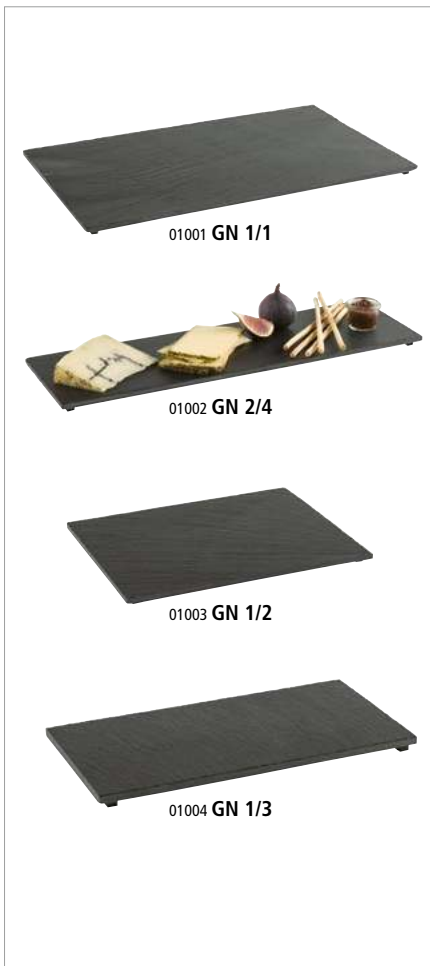

**GN Naturschieferplatte „VALO“**

GN natural slate tray  
GN bandeja pizarra natural  
GN plat ardoise naturelle

**gerade Kanten**

straight edges  
bordes rectos  
bords rectilignes



	cm	✱ mm	GN	€
01001	53,0 x 32,5	6 - 9	1/1	16,40
01002	53,0 x 16,2	6 - 9	2/4	6,80
01003	32,5 x 26,5	6 - 9	1/2	9,20
01004	32,5 x 17,6	6 - 9	1/3	5,60



gerade Kanten  
straight edges

# NATURAL SLATE TRAYS



**Naturschieferplatte „MORRA“**  
 natural slate tray  
 bandeja de pizarra natural  
 plat ardoise naturelle



	cm	✦ mm		€
00996	45 x 30	6 - 9		12,60
00979	58 x 38	6 - 9	mit Safrille / with juice groove	19,00



00979 mit Safrille  
 00979 with juice groove



**Naturschieferplatte „MORRA“**  
 natural slate tray  
 bandeja de pizarra natural  
 plat ardoise naturelle



	cm	✦ mm		€
00994	25 x 25	6 - 9		6,40
00995	30 x 30	6 - 9		9,50



**Naturschieferplatte „MORRA“**  
 natural slate  
 bandeja de pizarra natural  
 plateau ardoise naturelle



	cm	✦ mm	fits to	€
00941	24,0 x 15,0	6 - 9	83417	4,20
00942	26,5 x 20,5	6 - 9	83480	6,40
00945	47,0 x 10,0	6 - 9	83433	6,40
00988	30,0 x 12,0	6 - 9	83403	4,30

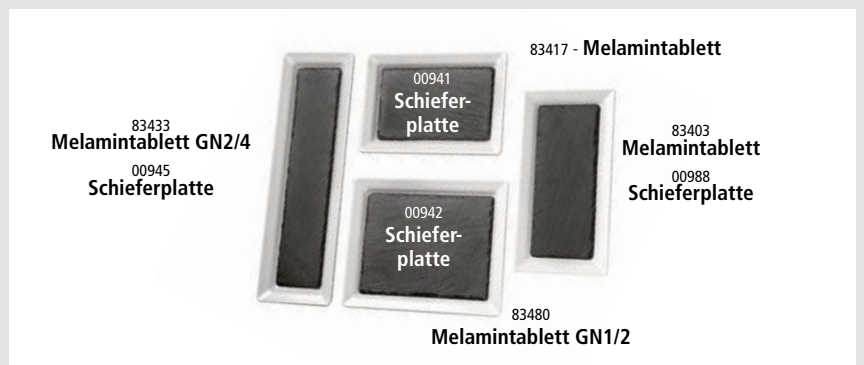



**Naturschieferplatte „MORRA“**

natural slate tray  
bandeja pizarra natural  
plat ardoise naturelle  
mit Safrille, mit Aussparung Ø 9,5 cm  
with juice groove, with hole Ø 9,5 cm  
con ranura para líquidos, con agujero Ø 9,5 cm  
avec rigole, avec trou Ø 9,5 cm



	cm	mm	€
00947	33 x 24	6 - 9	9,20



mit Safrille  
with juice groove

Wachspapier / greaseproof paper squares / papel alimenticio / papier alimentaire

	cm	pcs.	Motiv: Zeitung	€
40670	42 x 25	500		59,00

Servier-Frittierkorb / fry baskets / cestitas para el servicio mesa / paniers pour le service sur table

	Ø cm	↑ cm	Griff / handle cm	Farbe / colour	€
40601	9	8,5	9,0	stainless steel	11,20
40603	9	8,5	9,0	copper	13,00
40625	9	8,5	9,0	black matt	13,60



**Naturschieferplatte „MORRA“**

natural slate tray  
bandeja pizarra natural  
plat ardoise naturelle  
mit 3 x Aussparungen, Ø 6 cm  
with 3 holes, Ø 6 cm  
con 3 agujeros, Ø 6 cm  
avec 3 trous, Ø 6 cm



	cm	mm	€
00987	28 x 10	6 - 9	6,20

passende Gläser:  
82310, 82312, 82314, 82316



**Naturschieferplatte „MORRA“**

natural slate tray  
bandeja pizarra natural  
plat ardoise naturelle  
mit Aussparung, Ø 6 cm  
with hole Ø 6 cm  
con agujero Ø 6 cm  
avec trou Ø 6,0 cm



	cm	mm	€
00986	25 x 12	6 - 9	4,40

passende Gläser:  
82310, 82312, 82314, 82316



**Naturschieferplatte / Untersetzer**

natural slate tray  
bandeja de pizarra natural  
plateau ardoise naturelle  
mit 2 Aussparungen, Ø 6 cm  
with 2 holes Ø 6 cm  
con 2 agujeros Ø 6 cm  
avec 2 trous Ø 6 cm



	cm	mm	€
00971	15 x 8	6 - 9	3,40

## NATURAL SLATE TRAYS



**Naturschieferplatte „MORRA“**  
 natural slate tray  
 bandeja de pizarra natural  
 plat ardoise naturelle



	cm	✱ mm	€
00937	20 x 10	6 - 9	3,10



00969

**Naturschieferplatte „MORRA“**  
 natural slate tray  
 bandeja de pizarra natural  
 plat ardoise naturelle



	Ø cm	✱ mm	€
00968	22	6 - 9	5,20
00969	28	6 - 9	7,30
00998	33	6 - 9	8,70
00999	38	6 - 9	12,80



Präsentationsmöglichkeit  
 presentation example



**Tortenplatte / Servierplatte „MORRA“**  
 cake stand  
 soporte para pastel  
 présentoir à gâteaux



	Ø cm	↑ cm	✱ mm	€
00975	32	2,5	6 - 9	19,60



drehbare Servierplatte  
 rotatable cake stand



3 tlg.  
 3 pcs.

**Rolltop-Set, 3-teilig „MORRA“**  
 rolltop set, 3 pcs.  
 rolltop, set de 3  
 rolltop, set de 3



1 Edelstahltablett Ø 38 cm + 1 Naturschieferplatte Ø 33 cm + 1 Rolltophaube Ø 38 cm  
 1 stainless tray Ø 38 cm + 1 natural slate tray Ø 33 cm + 1 rolltop cover Ø 38 cm  
 1 bandeja de acero inoxidable Ø 38 cm + 1 bandeja de pizarra natural Ø 33 cm  
 + 1 tapa abatible Ø 38 cm  
 1 plat inox Ø 38 cm + 1 plat ardoise naturelle Ø 33 cm + 1 cloche Ø 38 cm

	Ø cm	↑ cm	€/ set
01000	38	24	54,00



**3-stufige Etagère „MORRA“**

3-tier tray  
bandeja con tres alturas  
étagère carré 3 hauteurs

Naturschieferplatten Ø 30 / 25 / 20 cm  
natural slate trays Ø 30 / 25 / 20 cm  
losas de pizarra natural Ø 30 / 25 / 20 cm  
plaques d'ardoise naturelle Ø 30 / 25 / 20 cm



	Ø cm	↑ cm	* mm	€
00960	30 / 25 / 20	34	6 - 9	29,00



**2-stufige Etagère „MORRA“**

2-tier tray  
bandeja dos alturas  
étagère carré 2 hauteurs

Naturschiefer Ø 25 / 20 cm  
natural slate tray Ø 25 / 20 cm  
bandeja de pizarra natural Ø 25 / 20 cm  
plateau ardoise naturelle Ø 25 / 20 cm



	Ø cm	↑ cm	* mm	€
00989	25 / 20	24	6 - 9	14,80



**Naturschieferplatte „MORRA“**

natural slate tray  
bandeja de pizarra natural  
plateau ardoise naturelle

2-teilig: Naturschieferplatte mit Glashaube  
2 pcs.: natural slate tray with glass cover  
set de 2: bandeja de pizarra natural con tapa de cristal  
set de 2: plateau ardoise naturelle avec cloche en verre

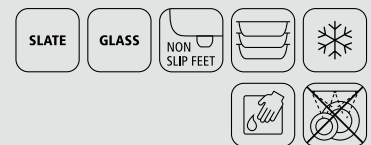

	Ø cm	↑ cm	* mm	€
00984	10,5	8	6 - 9	8,50



**Naturschieferplatten, 4er Set „MORRA“**

natural slate tray, 4 pcs.  
bandeja pizarra natural, set de 4  
plateau ardoise naturelle, set de 4



	cm	* mm	pcs.	€ / set
00997	10 x 10	6 - 9	4	8,50

## STAINLESS STEEL TRAYS



### GN 1/1 System-Tablett „PROFI LINE“

GN 1/1 tray  
GN 1/1 bandeja  
GN 1/1 plateau



**Dekorrand, hochglanzpoliert, Griffe verchromt, Distanzstücke erhöhen die Nutzhöhe auf 4 cm**  
decor edge, mirror polished, chrome plated handles, spacers increase the useful height to 4 cm  
borde decorado pulido brillante, asas cromadas, los separadores aumentan la altura útil a 4 cm  
bord avec reliefs poli brillant, poignées chromées, les entretoises portent la hauteur utile à 4 cm

	cm	↑ cm	GN	€
11300	53 x 32,5	5,5	1/1	49,00



Präsentationsmöglichkeit  
presentation example



### GN 1/1 System-Tablett „BUFFET-STAR“

GN 1/1 tray  
GN 1/1 bandeja  
GN 1/1 plateau



**Rand hochglanzpoliert, Distanzstücke erhöhen die Nutzhöhe auf 4 cm**  
mirror polished edge, spacers increase the useful height to 4 cm  
borde pulido brillante, los separadores aumentan la altura útil a 4 cm  
bord poli brillant, les entretoises portent la hauteur utile à 4 cm

	cm	↑ cm	GN	Griff / handle	€
11150	53 x 32,5	6,5	1/1	silver	40,00
11155	53 x 32,5	6,5	1/1	gold	40,00



Präsentationsmöglichkeit  
presentation example



### GN 1/1 System-Tablett „CLASSIC“

GN tray  
GN bandeja  
GN plat empilable système catering



**Rand hochglanzpoliert, Distanzstücke erhöhen die Nutzhöhe auf 4 cm**  
mirror polished edge, spacers increase the useful height to 4 cm  
borde pulido brillante, los separadores aumentan la altura útil a 4 cm  
bord poli brillant, les entretoises portent la hauteur utile à 4 cm

	cm	↑ cm	GN	€
11295	53 x 32,5	5,0	1/1	42,00



### GN 1/1 Haube „HOCHSTAPLER“

GN 1/1 cover  
GN 1/1 campana  
GN 1/1 cloche



**glasklarer Kunststoff, Haube fixiert sich auf dem Tablett, nahezu bruchfest**  
clear plastic, cover fixes itself on the tray, nearly unbreakable  
plástico transparente, la tapa se fija a la bandeja para que no se deslice, resistente a la rotura  
en plastique transparent, la cloche se fixe sur le dessous du plateau, résistant à la casse

	cm	↑ cm	fits to	GN	€
11305	53 x 32,5	9	11300, 11295	1/1	30,00



**GN Edelstahl Tablett „FRAMES“**

GN stainless steel platter  
GN bandeja acero inoxidable  
GN plateau acier inox



	cm	↑ cm	GN	€
11119	53,0 x 32,5	2	1/1	33,00



**GN Tablett „PROFI LINE“**

GN tray  
GN bandeja  
GN plateau



mit glattem Rand / with smooth edge / borde liso / bord lisse

	cm	↑ cm	GN	€
11100	53,0 x 32,5	1,5	1/1	31,00
12100	32,5 x 26,5	1,5	1/2	17,80

mit Dekor-Rand / with decor-edge / con borde decorado / bords avec relief

	cm	↑ cm	GN	€
11000	53,0 x 32,5	1,5	1/1	31,00
12000	32,5 x 26,5	1,5	1/2	19,60

glatter schmaler Rand / smooth narrow edge / borde estrecho liso / bord étroit lisse

	cm	↑ cm	GN	€
11110	53,0 x 32,5	1,0	1/1	20,00

**GN Abdeckhaube**

GN cover  
GN campana  
GN cloche



	cm	↑ cm	✱ mm	GN	€
11041	32,5 x 26,5	9,5	3	1/2	23,00
11042	53,0 x 32,5	9,5	3	1/1	32,00
11043	32,5 x 17,6	10,5	3	1/3	17,00
11044	53,0 x 16,2	10,5	3	2/4	23,00



## STAINLESS STEEL TRAYS



### Tablett „SCHÖNER ESSEN“

tray  
bandeja  
plateau

mit Dekorrand, Griffe Zinkdruckguss verchromt, genietet

with decor edge, handles zinc alloy chrome plated, riveted

borde decorado, asas de fundición inyectada de cinc cromado, remachadas

bord décor, poignées en zamac chromé, rivetées



	cm	↑ cm	€
00082	54 x 31,0	3	16,00
00081	62 x 36,0	3	22,00
00084	75 x 44,5	3	38,00



### Tablett „SCHÖNER ESSEN“

tray  
bandeja  
plateau



	cm	↑ cm	GN	€
00383	35,0 x 24,0	1		7,60
00382	42,0 x 31,0	1		11,80
00381	50,0 x 36,0	1		15,00
00384	63,5 x 44,5	1		29,00
00385	60,0 x 40,0	1		27,00
00388	53,0 x 32,5	1	1/1	17,00

leichte Ausführung 0,5 mm / light model / modelo ligero / qualité légère

	cm	↑ cm	€
03824	42,0 x 31,0	1	10,60



### Tablett mit Haube „SCHÖNER ESSEN“

tray with cover  
bandeja con campana  
plateau avec cloche



	cm	↑ cm	€
38202	42 x 31	8	16,80

Haube / cover / campana / cloche

	cm	↑ cm	€
08201	36,5 x 26,0	7,5	5,40



Tablett „FINESSE“

tray  
bandeja  
plateau



verchromte Messinggriffe / chrome plated brass handles / asas plateadas de latón / poignées en laiton chromées

	cm	↑ cm	€
01712	44 x 31	1,5	22,40



01338

Tablett „FINESSE“

tray  
bandeja  
plateau



	Ø cm	↑ cm	€
01332	32	1	9,40
01335	35	1	11,00
01338	38	1	12,40
01348	48	1	24,00



01311

Tablett „FINESSE“

tray  
bandeja  
plateau



	cm	↑ cm	€
01317	39 x 26	1	11,00
01312	42 x 31	1	12,40
01318	48 x 30	1	11,80
01311	50 x 38	1	17,20
01310	58 x 42	1	29,00
01309	68 x 48	1	41,00

## STAINLESS STEEL TRAYS



### Tablett „ELEGANCE“

tray  
bandeja  
plateau



	cm	↑ cm	€
02311	48 x 30	1	17,00



### Schale

bowl  
cuenco  
bol  
eingerollter Rand  
rolled edge  
borde enrollado  
bord roulé



	cm	↑ cm	ltr.	€
40110	26,5 x 18,5	4	0,8	9,20



### Servierpfanne

pan  
fuente para la mesa  
plat pour la table

mit vergoldeten Edelstahlgriffen, 1 mm dick  
with gold-plated stainless steel handles, 1 mm thick  
con asas doradas de acero inoxidable de 1 mm de grosor  
avec poignées dorées en acier inox, 1 mm d'épaisseur



	cm	↑ cm	ltr.	€
61190	Ø 19	3,5	0,7	16,40
61280	Ø 28	4,0	2,0	24,00
60270	26,5 x 19,5	3,0	0,8	18,40
60310	31,0 x 21,5	3,0	1,2	23,00



### Tablett „TREND“

baking sheet  
bandeja  
plateau

ein Backblech wird zum Serviertablett

a baking sheet which becomes a serving tray

una bandeja de hornear que se convierte en una bandeja de servir

un moule qui devient un plateau de service



	cm	↑ cm	Farbe / colour	€
13380	32 x 21,5	2	aluminium	10,60
13381	37 x 26,5	2	aluminium	12,00

# VINTAGE



## Tablett „VINTAGE“

tray  
bandeja  
plateau

Vintage-Look



	cm	↑ cm	€
30130	26,0 x 13,5	1,5	8,80
30131	34,0 x 18,0	1,5	14,00
30132	38,0 x 26,5	1,5	22,00
30133	25,5 x 16,0	3,0	17,00
30134	32,5 x 21,5	2,0	17,40

## passende Schälchen / fitting bowls / cuencos adecuados / bols appropriés



	Ø cm	↑ cm	ltr.	€
40655	7,5	5,5	0,17	3,20
40656	7,5	10,0	0,35	4,00

## Wachspapier / greaseproof paper squares / papel alimenticio / papier alimentaire

	cm	pcs.	Motiv:	€
40670	42 x 25	500	Motiv: Zeitung	59,00



Präsentationsmöglichkeit  
presentation example

## STAINLESS STEEL TRAYS



### Serviertablett „KAFFEEHAUS“

tray  
bandeja  
plateau

hochglanzpoliert, stabiler Rand eingerollt  
mirror polished, stable edge rolled in  
pulido brillante, borde estable enrollado  
poli brillant, bord stable enroulé



	cm	↑ cm	€
30148	Ø 27	1,5	6,00
30149	30 x 15,5	1,5	6,80

passende Hauben / cover / campana / cloche



	cm	↑ cm	suitable for	€
11055	Ø 23	12	30148	5,70
11056	26 x 12	10	30149	7,90



Präsentationsmöglichkeit  
presentation example



### Serviertablett „KAFFEEHAUS“

tray  
bandeja  
plateau

matt poliert, oval, Rand eingerollt  
matt polished, oval, rolled edge  
pulido mate, oval, borde enrollado  
poli mat, ovale, bord enroulé



	cm	↑ cm	€
30111	20,0 x 14,5	0,5	für Zucker und Sahne / for sugar and cream 4,70
30112	26,5 x 19,5	0,5	für eine Tasse / for one cup 7,00
30113	29,0 x 22,0	0,5	für zwei Tassen / for two cups 7,50



### Serviertablett „KAFFEEHAUS“

tray  
bandeja  
plateau

hochglanzpoliert, oval, Rand eingerollt  
mirror polished, oval, rolled edge  
pulido brillante, ovalado, borde enrollado  
poli brillant, ovale, bord enroulé



	cm	↑ cm	€
30115	20,0 x 14,5	0,5	für Zucker und Sahne / for sugar and cream 4,70 para azúcar y crema / pour le sucre et la crème
30116	26,5 x 19,5	0,5	für eine Tasse / for one cup 7,00 para una taza / pour une tasse
30117	29,0 x 22,0	0,5	für zwei Tassen / for two cups 7,50 para dos tazas / pour deux tasses



Serviertablett „KAFFEEHAUS“

tray  
bandeja  
plateau



**matt poliert, Rand eingerollt**

matt polished, rolled edge  
pulido mate, borde enrollado  
poli mat, bord enrollé

	cm	↑ cm	€
30118	21,5 x 13	1,5	7,90
30119	23,0 x 23	1,5	10,90



Serviertablett „KAFFEEHAUS“

tray  
bandeja  
plateau



	cm	↑ cm	€
84251	26,0 x 20,0	1,5	5,20
84253	28,5 x 21,5	1,5	5,80



Serviertablett „KAFFEEHAUS“

tray  
bandeja  
plateau



**Innenfläche ziseliert, Rand eingerollt**

chiselled inner surface, rolled edge  
superficie interior cincelada, borde enrollado  
surface intérieure ciselée, bord enrollé

	cm	↑ cm	VE / unit	€ / pc.
30114	30 x 22	1	48	3,00

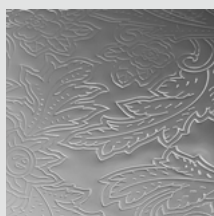

Ziselierung Innenfläche  
chiselling inner surface

## TRAYS



### Tablett mit Haube „ELEGANCE“

tray with cover  
bandeja con campana  
plateau avec cloche

2-teilig: Tablett aus Edelstahl + Haube

2 pcs.: stainless steel tray + cover

set de 2: bandeja de acero inoxidable + campana

set de 2: plateau en acier inox + cloche



	cm	↑ cm	€
00064	33 x 17	10	10,20
00067	25 x 19	7	9,40

Haube für 00064 / cover for 00064 / campana para 00064 / cloche pour 00064

	€
06401	4,00

Haube für 00067 / cover for 00067 / campana para 00067 / cloche pour 00067

	€
06701	3,00



### Tortenplatte

cake plate  
bandeja tartas  
plat à gâteau

2-teilig: Tablett aus Edelstahl + Haube

2 pcs.: stainless steel tray + cover

set de 2: bandeja de acero inoxidable + campana

set de 2: plateau en acier inox + cloche



	Ø cm	↑ cm		€
00065	30	11	mit 1 Haube / with 1 cover	9,60
00652	30	7 + 11	mit 2 Hauben / with 2 cover	12,40



### Tortenplatte „BAROCK“

cake plate  
bandeja tartas  
plat à gâteau

2-teilig: Tortenplatte mit Barock-Rand + Haube

2 pcs.: cake plate with decor edge „Barock“ + cover

set de 2: porta tartas, borde decor „Barock“ + campana

set de 2: plateau bord décor „Barock“ + cloche



	Ø cm	↑ cm	€
06503	32	12	13,20

Frischhaltehaube / cover / campana / cloche

	Ø cm	↑ cm	€
06510	30	11,5	5,90

2 tlg.  
2 pcs.**Tablett mit Haube „FINESSE“**tray with cover  
bandeja con campana  
plateau avec cloche**2-teilig: Tablett aus Edelstahl + Haube**2 pcs.: stainless steel tray + cover  
set de 2: bandeja de acero inoxidable + campana  
set de 2: plateau en acier inox + cloche

	cm	↑ cm	€
13122	42 x 31	8,5	22,00

2 tlg.  
2 pcs.**Tablett mit Haube „FINESSE“**tray with cover  
bandeja con campana  
plateau avec cloche**2-teilig: Tablett aus Edelstahl + Haube**2 pcs.: stainless steel tray + cover  
set de 2: bandeja de acero inoxidable + campana  
set de 2: plateau en acier inox + cloche

	Ø cm	↑ cm	€
13622	22	9,5	8,60

2 tlg.  
2 pcs.

13382

**Tablett mit Haube „FINESSE“**tray with cover  
bandeja con campana  
plateau avec cloche**2-teilig: Tablett aus Edelstahl + Haube**2 pcs.: stainless steel tray + cover  
set de 2: bandeja de acero inoxidable + campana  
set de 2: plateau en acier inox + cloche

	Ø cm	↑ cm	Ø cm Hauben / cover	€
13382	38	12	30	22,40
13385	38	13	33	23,60



06515

**Frischhaltehaube**cover  
campana  
cloche**glasklar, schwere stabile Ausführung** / clear, heavy stable quality /  
transparente, alta estabilidad / transparente, très stable

	Ø cm	↑ cm	€
06510	30	11,5	5,90
06515	33	12,5	7,50



06512

**Frischhaltehaube**cover  
campana  
cloche**glasklar, schwere stabile Ausführung** / clear, heavy stable quality /  
transparente, alta estabilidad / transparente, très stable

	Ø cm	↑ cm	€
06512	30	11,5	8,20
06517	33	12,5	9,60

mit verchromtem Griff / with chrom plated handle  
con botón cromado / avec bouton chromé  
mit verchromtem Griff / with chrom plated handle  
con botón cromado / avec bouton chromé

## TRAYS



### Tablett mit Haube, 2 teilig

tray with cover, 2 pcs.  
bandeja con campana, set de 2  
plateau avec cloche, set de 2

#### Tablett aus Bambus, ölimprägniert + Haube

bamboo tray, oil-impregnated + cover  
bandeja de bambú, impregnada de aceite + campana  
plateau en bambou, imprégné d'huile + cloche



	Ø cm	↑ cm	€
00822	20,5	10	9,60



### Tablett mit Haube, 2-teilig

tray with cover, 2 pcs.  
bandeja con campana, set de 2  
plateau avec cloche, set de 2

#### Tablett aus Bambus, ölimprägniert + Haube

bamboo tray, oil-impregnated + cover  
bandeja de bambú, impregnada de aceite + campana  
plateau en bambou, imprégné d'huile + cloche



	Ø cm	↑ cm	€
00825	25	13,5	12,00



### Tablett mit Haube, 2-teilig

tray with cover, 2 pcs.  
bandeja con campana, set de 2  
plateau avec cloche, set de 2

#### Tablett aus Bambus, ölimprägniert + Haube

bamboo tray, oil-impregnated + cover  
bandeja de bambú, impregnada de aceite + campana  
plateau en bambou, imprégné d'huile + cloche



	cm	↑ cm	€
00826	28 x 14	11,5	11,00



### Tablett mit Haube, 2 teilig

tray with cover, 2 pcs.  
bandeja con campana, set de 2  
plateau avec cloche, set de 2

#### Tablett aus Bambus, ölimprägniert + Haube

bamboo tray, oil-impregnated + cover  
bandeja de bambú, impregnada de aceite + campana  
plateau en bambou, imprégné d'huile + cloche



	cm	↑ cm	€
00820	24 x 18,5	8	8,00
00821	32 x 16,5	11	11,00

2 tlg.  
2 pcs.**Rolltop-Set**rolltop set  
set rolltop  
set cloche à fromage**2-teilig: Tablett + Rolltophaube glasklar, rutschfeste Haubenfixierung, klappbar**

2 pcs.: tray + rolltop cover, cover non-slip fixed, mountable

set de 2: bandeja + campana abatible fijación antideslizante, montable

set de 2: plateau + cloche abattante, fixation antidérapants, montable

	Ø cm	↑ cm	€
09080	38	24	44,00

3 tlg.  
3 pcs.**Rolltop-Set, 3-teilig „MORRA“**rolltop set, 3 pcs.  
rolltop, set de 3  
rolltop, set de 3**1 Edelstahltablett Ø 38 cm + 1 Naturschieferplatte Ø 33 cm + 1 Rolltophaube Ø 38 cm**

1 stainless tray Ø 38 cm + 1 natural slate tray Ø 33 cm + 1 rolltop cover Ø 38 cm

1 bandeja de acero inoxidable Ø 38 cm + 1 bandeja de pizarra natural Ø 33 cm  
+ 1 tapa abatible Ø 38 cm

1 plat inox Ø 38 cm + 1 plat ardoise naturelle Ø 33 cm + 1 cloche Ø 38 cm

	Ø cm	↑ cm	€
01000	38	24	54,00

4 tlg.  
4 pcs.**Kaviarkühler**caviar cooler  
enfriador de caviar  
rafraîchisseur de caviar**4-teilig: 1 Edelstahlschale, 1 Halter, 1 Glasschale, 1 Edelstahldeckel**

4 pcs.: 1 stainless steel bowl, 1 holder, 1 glass bowl Ø 10 cm, 1 stainless steel cover

set de 4: 1 bol de acero inoxidable, 1 soporte, 1 bol de vidrio Ø 10 cm, 1 tapa de acero inoxidable

set de 4: 1 bol en acier inox, 1 support, 1 bol en verre Ø 10 cm, 1 couvercle en acier inox

	Ø cm	↑ cm	€
01699	18	12	56,00

# FAST FOOD



Tablett „FAST FOOD“  
tray  
bandeja  
plateau



	cm	↑ cm	GN	Farbe / colour	VE / unit	€/ pc.
00530	35 x 27,0	2			6	3,50
00535	41 x 30,5	2			6	4,70
00540	45 x 35,5	2			6	5,90
00552	53 x 32,5	2	1/1		6	7,20
00531	35 x 27,0	2			6	3,50
00536	41 x 30,5	2			6	4,70
00541	45 x 35,5	2			6	5,90
00553	53 x 32,5	2	1/1		6	7,20
00532	35 x 27,0	2			6	3,50
00537	41 x 30,5	2			6	4,70
00542	45 x 35,5	2			6	5,90
00554	53 x 32,5	2	1/1		6	7,20
00533	35 x 27,0	2			6	3,50
00538	41 x 30,5	2			6	4,70
00543	45 x 35,5	2			6	5,90
00555	53 x 32,5	2	1/1		6	7,20
00534	35 x 27,0	2			6	3,50
00539	35 x 27,0	2			6	3,50



stapelbar  
stackable



00396



00398



00399



GN 2/3 00389



GN 1/1 00395

Partyplatte

partytray  
bandeja party  
plateau party

Rand eingerollt

rolled edge

borde enrollado

bord enroulé



	cm	↑ cm	GN		VE / unit	€ / pc.
00396	Ø 35	1,5	-	round	24	5,20
00398	46,0 x 34,0	1,5	-	oval	24	5,20
00399	41,0 x 31,0	1,5	-		24	5,20
00389	35,4 x 32,5	1,5	2/3		24	5,00
00395	53,0 x 32,5	1,5	1/1		24	8,20



00393



00391



00392



GN 1/1 00394

Partyplatte

partytray  
bandeja party  
plateau party

Rand eingerollt, Innenfläche ziseliert

rolled edge, chiselled inner surface

borde enrollado, superficie interior cincelada

bord enroulé, surface intérieure ciselée



	cm	↑ cm		VE / unit	€ / pc.
00393	Ø 35	1,5	round	24	5,20
00391	46 x 34	1,5	oval	24	5,20

	cm	↑ cm	GN	VE / unit	€ / pc.
00392	41 x 31,0	1,5	-	24	5,20
00394	53 x 32,5	1,5	1/1	24	8,20

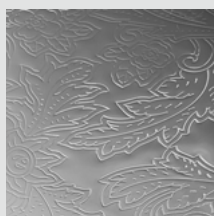

Ziselierung Innenfläche  
chiselling inner surface

# NON-SLIP TRAYS



## Serviertablett „NOSLIDE“

tray  
bandeja  
plateau



rutschfeste Oberfläche / non-slip surface / superficie anti-deslizante / surface antidérapante

	cm	↑ cm	GN	€
00516	53 x 32,5	2,5	1/1	13,00
00517	53 x 36,5	2,0		16,00



## Tablett „NOSLIDE“

tray  
bandeja  
plateau



rutschfeste Oberfläche / non-slip surface / superficie antideslizante / surface antidérapante

	Ø cm	↑ cm	€
00547	27,5	2	7,60
00548	35,5	2	9,60
00549	40,5	2	11,40

**Serviertablett „GRIPZONE“**

tray non-slip  
bandeja  
plateau



rutschfeste Oberfläche / non-slip surface / superficie antideslizante / surface antidérapante

	cm	↑ cm	GN	€
00502	53,0 x 32,5	1,5	1/1	27,00
00508	46,0 x 36,0	2,0		24,80

**Bierglasträger „GRIPZONE“**

beer rack  
bandeja para cerveza  
porte verre à bière



rutschfeste Oberfläche / non-slip surface / superficie antideslizante / surface antidérapante

	Ø cm	↑ cm	€
00500	36	3,5	23,00
00506	28 x 20	1,5	10,40

**Tablett „BISTRO“**

tray  
bandeja  
plateau



rutschfest, mit 2 Griffmulden und Stapelrand

non-slip, two open handles, stackable edge  
antideslizante, con 2 asas y borde apilable  
antidérapant, avec 2 poignées et bord d'empilage

	Ø cm	↑ cm	€
84045	35,5	4,5	26,00

# CAKE STANDS



NEW

## Frischhaltehaube „VALO“

cover  
campana  
cloche



stilvoll abgedeckt und geschützt – passend für Servier- und Tortenplatten Nr. 14095 & 14096  
stylishly covered and protected – compatible with cake stands no. 14095 & 14096  
elegante y protegida – compatible con porta pasteles no. 14095 & 14096  
couverts et protégés avec style – compatible avec présentoir à gâteaux no. 14095 & 14096

	Ø cm	↑ cm	fits to	€
14097	30	16	00046, 00463, 00468, 00469, 14095, 14096, 33294, 33295, 83890, 83891	35,00



NEW

## Servier- und Tortenplatte „VALO“

cake stand  
porta pasteles  
présentoir à gâteaux



für eine stilvolle Präsentation von Kuchen und Gebäck, Ø Standfuß: 12 cm  
for a stylish presentation of cakes and pastries, Ø base: 12 cm  
presentación elegante de pasteles y repostería, Ø base: 12 cm  
présentation élégante de gâteaux et pâtisseries, Ø socle: 12 cm

	Ø cm	↑ cm	fits to	Farbe / colour	€
14095	32	8,5	14097	(oiled)	89,00



NEW

## Servier- und Tortenplatte „VALO“

cake stand  
porta pasteles  
présentoir à gâteaux



für eine stilvolle Präsentation von Kuchen und Gebäck, Ø Standfuß: 15 cm  
for a stylish presentation of cakes and pastries, Ø base: 15 cm  
presentación elegante de pasteles y repostería, Ø base: 15 cm  
présentation élégante de gâteaux et pâtisseries, Ø socle: 15 cm

	Ø cm	↑ cm	fits to	Farbe / colour	€
14096	32	17	14097	(oiled)	99,00



**Servier- und Tortenplatte „ACACIA“**

cake stand  
 porta pasteles  
 présentoir à gâteaux  
 Akazienholz geölt  
 acacia wood oiled  
 madera de acacia aceitada  
 bois d'acacia huilé



	Ø cm	↑ cm	€
33292	24,0	8	53,00
33293	24,0	16	68,00
33294	33,0	8	74,00
33295	33,0	16	100,00
33296	38,5	8	90,00
33297	38,5	16	116,00



**Frischhaltehaube „DOME“ / cover / campana / cloche**



	Ø cm	↑ cm	fits to	€
06519	21	17	33292, 33293	30,00
06520	30	22	33294, 33295	37,00
06521	36	27	33296, 33297	74,00



## CAKE STANDS



### Servier- und Tortenplatte „CASUAL“

cake plate  
porta pasteles  
présentoir à gâteaux



	Ø cm	↑ cm	€
83890	31	8	28,60
83891	31	16	36,00
	cm	↑ cm	€
83892	31 x 31	8	32,00
83893	31 x 31	16	39,00



### Servier- und Tortenplatte „CASUAL“

cake stand  
porta pasteles  
présentoir à gâteaux



Rand fixiert die Haube, mit Antirutschfüßchen  
carved edge fixes the cover, with non-slip feet  
ranura para fijar bien la campana, con pies antideslizantes  
bord rainuré pour maintenir ferme la cloche, avec pieds antidérapants

	Ø cm	↑ cm	Farbe / colour	fits to cover	€
00468	31	3,5	White	06520, 06525	18,40
00469	31	3,5	Black	06520, 06525	18,40



### Servier- und Tortenplatte

cake stand  
porta pasteles  
présentoir à gâteaux



matt poliert, drehbar  
matt polished, rotating  
pulido mate, giratoria  
poli mat, pivotant

	Ø cm	↑ cm	fits to cover	€
00463	30,5	9	06520, 06525	52,00



### Servier- und Tortenplatte

cake stand  
porta pasteles  
présentoir à gâteaux



matt poliert / matt polished / pulido mate / poli mat

	Ø cm	↑ cm	€
00046	31	3	16,00

# SUPER DOME



06525 Ø 30 cm

## Frischhaltehaube „SUPER DOME“

cover  
campana  
cloche

schwere, glasklare Qualität  
stable, crystal clear quality  
muy resistente y transparencia cristalina  
haute résistance et transparence



	Ø cm	↑ cm	€
06525	30	40	74,00

passende Servier-/Tortenplatten / suitable cake stands / porta pasteles compatibles /  
présentoirs à gâteaux compatibles

	Ø cm	↑ cm	Farbe / colour	€
00468	31	3,5		18,40
33294	33	8,0		74,00
33295	33	16,0		100,00



Präsentationsmöglichkeiten  
presentation examples



06519 Ø 21 cm

## Frischhaltehaube „DOME“

cover  
campana  
cloche

schwere, glasklare Qualität  
stable, crystal clear quality  
calidad estable y transparencia cristalina  
qualité stable et clarté cristalline



	Ø cm	↑ cm	fits to	€
06519	21	17		30,00
06520	30	22	00046, 00463, 00468, 00469, 00975, 00998, 14095, 14096, 83884, 83890, 83891, 84177	37,00
06521	36	27		74,00



# SERVING BOARDS



## Servierbrett „VELVET“

serving board  
tabla de servir  
planche de service

Servierbrett aus geöltem Akazienholz  
serving board made of oiled acacia wood  
tabla de servir de madera de acacia aceitada  
planche en bois avec plateau en bois d'acacia huilé



	cm	↑ cm	€
00897	30 x 15	2	14,20
00898	30 x 18	2	16,50
00899	35 x 25	2	23,00



## Servierbrett

serving board  
tabla de servir  
planche de service

aus geöltem Akazienholz  
made of oiled acacia wood  
de madera de acacia aceitada  
en bois d'acacia huilé



	cm	↑ cm	€
00793	25 x 17	1,5	14,40



## Servierbrett

serving board  
tabla de servir  
planche de service

aus geöltem Akazienholz  
made of oiled acacia wood  
de madera de acacia aceitada  
en bois d'acacia huilé



	cm	↑ cm	€
00792	37 x 8	2	12,00

2 tlg.  
2 pcs.

## Servierbrett „FUSIONA“

serving board  
tabla de servir  
planche de service



2-teilig: 1 Holzbrett aus Akazienholz + 1 Naturschieferplatte

2 pcs.: 1 wood board made of acacia wood + 1 natural slate tray

set de 2: 1 tabla de madera de acacia + 1 pizarra natural

set de 2: 1 planche en bois d'acacia + 1 ardoise naturelle

	cm	↑ cm	€
00814	28 x 17,5	2	16,00



mit Aussparung ø 5 cm  
with hole ø 5 cm

2 tlg.  
2 pcs.

00810



00811



00812



00813

## Servierbrett „FUSIONA“

serving board  
tabla de servir  
planche de service



2-teilig: 1 Holzbrett aus Akazienholz + 1 Naturschieferplatte

2 pcs.: 1 wood board made of acacia wood + 1 natural slate tray

set de 2: 1 tabla de madera de acacia + 1 pizarra natural

set de 2: 1 planche en bois d'acacia + 1 ardoise naturelle

	cm	↑ cm	Griff / handle cm	€
00810	26 x 18	2	8	15,00
00811	33 x 20	2	8	18,40
00812	40 x 15	2	5	23,40
00813	43 x 12	2	12	19,00

Präsentationsmöglichkeit  
presentation example



00813

mit Hängeloch Ø 2 cm / with a handle-hole Ø 2 cm



**Servierbrett „ROCKWOOD“**

serving board  
 tabla de servir  
 planche de service



geeignet zur Beschriftung, mit Hängeloch Ø 1 cm  
 suitable for labeling, with hanging hole Ø 1 cm  
 apto para rotulación, con orificio para colgar Ø 1 cm  
 adapté pour l'étiquetage, avec trou de suspension Ø 1 cm

	cm	↑ cm	Griff / handle cm	€
00867	30,5 x 13	1,5	10	18,60
00868	36,5 x 15	1,5	12	23,60
00869	42,0 x 18	1,5	14	26,80



**Kreide-Marker, 2er Set**

chalk marker, 2 pcs.  
 rotulador de tiza, set de 2  
 marqueur a la craie liquide, set de 2



Zum Gestalten und Beschriften von Tafeln, Glas und fast allen geschlossenen Oberflächen,  
 deckende Flüssigkreide auf Wasserbasis, feucht abwischbar

For decorating and writing on boards, glass and almost all non-porous surfaces, opaque  
 water-based liquid chalk, wet-wipeable

Rotuladores para pizarra de tiza líquida para decorar y escribir sobre pizarras, cristales y casi  
 todas las superficies no porosas. Tizi líquida opaca al agua que se pueda borrar con un trapo  
 Pour décorations et inscriptions sur tableaux, verre et presque toutes les surfaces non  
 poreuses, craie liquide opaque à base d'eau, effaçable avec un chiffon humide

	Ø cm	↑ cm	Farbe / colour	pcs.	€ / set
71490	1	13	white	2	6,50



**Servierbrett „SHARING“**

serving board  
 tabla de servir  
 planche de service



Servierbrett aus geöltem Akazienholz  
 serving board made of oiled acacia wood  
 tabla de servir de madera de acacia aceitada  
 planche en bois d'acacia huilé

	cm	↑ cm	Griff / handle cm	€
00887	51,5 x 18	1,5	8,5	34,00

## ACACIA



00794 1,8 ltr.



00795 2,5 ltr.



00796 3,0 ltr.

## Schale „ACACIA“

bowl  
cuenco  
bol

aus geöltem Akazienholz  
made of oiled acacia wood  
de madera de acacia aceitada  
en bois d'acacia huilé



	Ø cm	↑ cm	ltr.	€
00794	21	8,5	1,8	40,00
00795	25	8,5	2,5	45,00
00796	27	8,5	3,0	50,00



3 Größen ineinander  
3 sizes in each other



33269

## Buffetständer „MULTI ROUND“

buffet stand  
soporte para buffet  
présentoir buffet

Metall, mit schwarzer Antirutschbeschichtung  
metal, with black anti-slide coating  
metal, con revestimiento antideslizante negro  
métal, avec revêtement antidérapant noir



	Ø cm	↑ cm	€
33269	15,5 / 18	8	10,90
33270	15,5 / 18	10	13,00
33271	15,5 / 18	18	16,70

# OLIVE

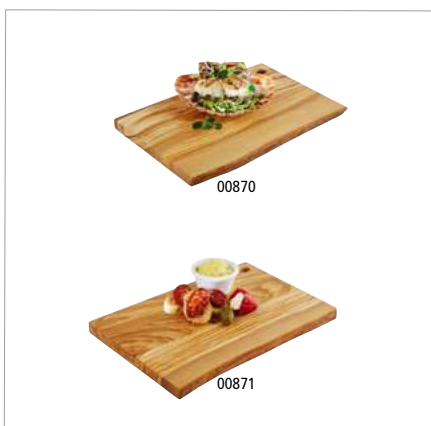

## Servierbrett „OLIVE“

servicing board  
 tabla de servir en madera de olivo  
 planche de service en bois d'olivier



aus geöltem Olivenholz, naturbedingte Abweichung in Form, Maserung und Größe  
 oiled olive wood, natural deviation in shape, grain and size  
 de madera de olivo aceitada, diferencias naturales posibles en forma, grano y tamaño  
 en bois d'olivier huilé, éventuelles différences naturelles de forme, de grain et de taille

	cm	↑ cm	€
00870	25 x 17,0	1,5	32,00
00871	30 x 20,5	2,0	52,00



## Servierbrett „OLIVE“

servicing board  
 tabla de servir en madera de olivo  
 planche de service en bois d'olivier



aus geöltem Olivenholz, naturbedingte Abweichung in Form, Maserung und Größe, mit Hängeloch Ø 2 cm

oiled olive wood, natural deviation in shape, grain and size, with hanging hole Ø 2 cm  
 de madera de olivo aceitada, diferencias naturales posibles en forma, grano y tamaño, con orificio para colgar Ø 2 cm  
 en bois d'olivier huilé, éventuelles différences naturelles de forme, de grain et de taille, avec trou de suspension Ø 2 cm

	cm	↑ cm	Griff / handle cm	€
00873	40 x 15,0	1,5	11	56,00
00874	44 x 20,0	2,0	12	72,00
00876	25 x 16,0	1,5	8	35,00
00877	31 x 20,0	1,5	9	52,00

★★★★★  
**COLAZIONE A 5 STELLE**

**FAS-ITALIA**  
FORNITURE PER ALBERGHI

**P R O G E T T A Z I O N E**

Fas Italia è sempre al fianco degli imprenditori come te e vogliamo aiutarti a migliorare la tua struttura ricettiva! Lo facciamo grazie all'intervento dei nostri esperti che hanno creato un servizio speciale per te! Da oggi puoi usufruire del servizio **Colazione a 5 stelle** grazie ai nostri esperti che ti seguiranno passo passo! **Ti rilasciamo un progetto completo che include il miglioramento della tua colazione e un preventivo di spesa e tante idee per aumentare il valore della percezione dei tuoi ospiti.**

### Cosa facciamo per te?

Analizziamo i tuoi bisogni per migliorare il servizio della colazione mediante interventi concreti prendendo in considerazione questi punti fondamentali:

✓ arredamento

✓ allestimento  
del buffet

✓ ambiente

✓ attrezzatura

✓ offerta alimentare

✓ food cost

✓ servizio di sala

✓ comunicazione



**FAS-ITALIA, UNO STAFF PRONTO A RISPONDERE A TUTTE LE TUE ESIGENZE**

ANDREA BARBARA ANTONELLA MANUELA GABRIELE STEFANO ALBERTO DUCCIO SIMONE DEBORA MANUELA VITO



**VIENI A TROVARCI IN SHOWROOM! TI ASPETTIAMO A FIRENZE!**

[www.salacolazione.it](http://www.salacolazione.it)

**FAS•ITALIA**  
**FORNITURE PER ALBERGHI**

**FAS ITALIA S.R.L.**

Via La Farina, 30r - 50132 Firenze

Tel. 055 470536 / 055 2479578

Fax 055 474345

P. IVA e C.F. 06061000482

[info@fas-italia.it](mailto:info@fas-italia.it)